User's Manual:SC10E08A/SC10E016A1

Industrial Serial Device Server



Content

1	Introduction	6
1.1	Product Overview	6
1.2	Features	6
2.	Getting Started	6
2.1	Model Comparison.....	6
2.3	Panel Layout and <i>Dimensions</i>	7
	LCM Configuration	9
1.1	Welcome Screen	9
1.2	Main Menu Structure	9
1.2.1	Overview.....	10
1.2.2	Network Settings	10
1.2.3	Serial Settings	11

1.2.1 Server State.....	14
1.2.2 Restart	14
3.Web Configuration	15
3.1 Administrator Login	15
3.2 Overview.....	16
3.3 Network Configuration	17
3.4 Serial	18
3.4.1 COM Configuration.....	19
3.4.2 COM Configuration: Advanced Settings	20
3.5 Alert Settings	22
3.5.1 Email Settings.....	22
3.5.2 Alert Event	24
3.6 System Configuration	24
3.6.1 Link State.....	25
3.6.2 Log Settings.....	26
3.6.3 System Log.....	27
3.6.4 COM Log	27
3.6.5 Time Settings.....	28
3.6.6 Security Configuration	29
3.6.7 Import/Export	30
3.6.8 Set to Default.....	30
3.6.9 Restart	30
4 CLI Configuration.....	31
4.1 Accessing the CLI.....	31
4.1.1 Serial Console	31
4.1.2 Telnet Console	31
4.2 General Information.....	32

4.3	Networking Configuration	39
4.3.1	LAN1 / LAN 2 Settings	39
4.3.2	DNS Settings	40
4.3.3	SNMP Settings	40
4.3.4	Redundancy Settings	41
4.4	COM Port Configuration	41
4.4.1	TCP Server for Link Mode	41
4.4.2	TCP Client for Link Mode	42
4.4.3	UDP Link Mode	42
4.4.4	Serial Settings	43
4.5	Alert Settings	43
4.5.1	Configuring E-mail	43
4.5.2	Configuring Alert Event	44
4.6	System Configuration	44
4.6.1	Link State	45
4.6.2	Time Settings	45
4.6.3	Security Settings	46
4.7	Restoring Factory Default	46
4.8	Restart System	47
5	Link Modes and Applications	47
5.1	Link Mode Configuration	47
5.1.1	TCP Server Mode	48
5.1.2	TCP Client Mode	50
5.1.3	UDP Mode	52
5.2	Link Mode Applications	54
5.2.1	TCP Server Application: Enable Virtual COM	54
5.2.2	TCP Server Application: Enable RFC 2217	55
5.2.3	TCP Client Application: Enable Virtual COM	55
5.2.4	TCP Client Application: Enable RFC 2217	56

5.2.5 TCP Server Application: Configure SC10E08A/ SC10E16A1 Series as a Pair Connection Master.....	56
5.2.6 TCP Client Application: Configure SC10E08A/ SC10E16A1 Series as a Pair Connection Slave.....	57
5.2.7 TCP Server Application: Enable Reverse Telnet	58
5.2.8 UDP Application: Multi-Point Pair Connection	59
5.2.9 TCP Server Application: Multiple TCP Connections	60
5.2.10 TCP Server Application: Multi-Point TCP Pair Connections	61
6 VCOM Installation & Troubleshooting.....	62
6.1 Enabling VCOM.....	62
6.1.1 VCOM driver setup	64
6.1.2 Limitations	64
6.1.3 Installation	65
6.1.4 Uninstalling	65
6.2 Enabling Virtual COM	65
6.2.1 Enable VCOM in Serial device servers	65
6.2.2 Running Serial/IP in Windows	66
6.2.3 Configuring VCOM Ports.....	68
6.2.4 Exceptions	70
6.3 Using Serial/IP Port Monitor	76
6.3.1 Opening the Port Monitor	76
6.3.2 The Activity Panel.....	76
6.3.3 The Trace Panel	77
6.3.4 Serial/IP Advanced Settings.....	77
6.3.5 Using Serial/IP with a Proxy Server	78
7 Specifications.....	79
7.1 Hardware	79
7.2 Software.....	80

7.3 Pin Assignments	80
7.3.1 Serial and RJ-45 Connectors	80
7.3.2 Serial and Female DB9 Connectors.....	81
7.3.3 Serial and Male DB9 Connectors	81
7.3.4 RJ-45 to Female DB9 Connection.....	82
7.3.5 RJ-45 to Male DB9 Connection	82
7.4 LED Indicators	83
7.5 Buzzer	84
8 Upgrade System Firmware	84
8.1 Upgrade Procedure	84
8.2 Error Messages	85

1 Introduction

1.1 Product Overview

SC10E08A/ SC10E16A1 Series is designed to transmit data between one-or-more serial devices and one-or-more TCP/IP devices through Ethernet

1.2 Features

- Dual 10/100Mbps Fast Ethernet for redundancy with full duplex auto negotiation
- Support RAW TCP Server/ TCP Client / UDP / Virtual COM / Tunneling Modes
- Configuration: Built-in Web Server /Serial Console/ Telnet / Windows-based Utility
- Monitor, manage and control industrial field devices remotely

2. Getting Started

2.1 Model Comparison

Model	Description
SC10E08A/ SC10E16A1 AC	08 -Port Serial Device Servers, RJ-45, AC 100~240V, US plug 16-Port Serial Device Servers, RJ-45, AC 100~240V, US plug
SC10E08A/ SC10E16A1 DC	08-Port Serial Device Servers, RJ-45, DC 24V 16-Port Serial Device Servers, RJ-45, DC 24V

2.2 Inside the Package

Inside the product purchased you will find the following items:

Item	Quantity	Description
SC10E08A/ SC10E16A1 Series	1	Industrial Serial Device Server
Cable	1	RJ-45 to Male DB9 cable AC Power cord (US Plug or EU Plug)
Rack Mount Kit	1	Mounting kit to mount the device on the 19" Rack
CD (Utilities)	1	<ul style="list-style-type: none"> ● User's Manual ● Installation Guide ● Serial Manager Utility

2.3 Panel Layout and Dimensions

Front and Rear Panels (SC10E08A/ SC10E16A1):

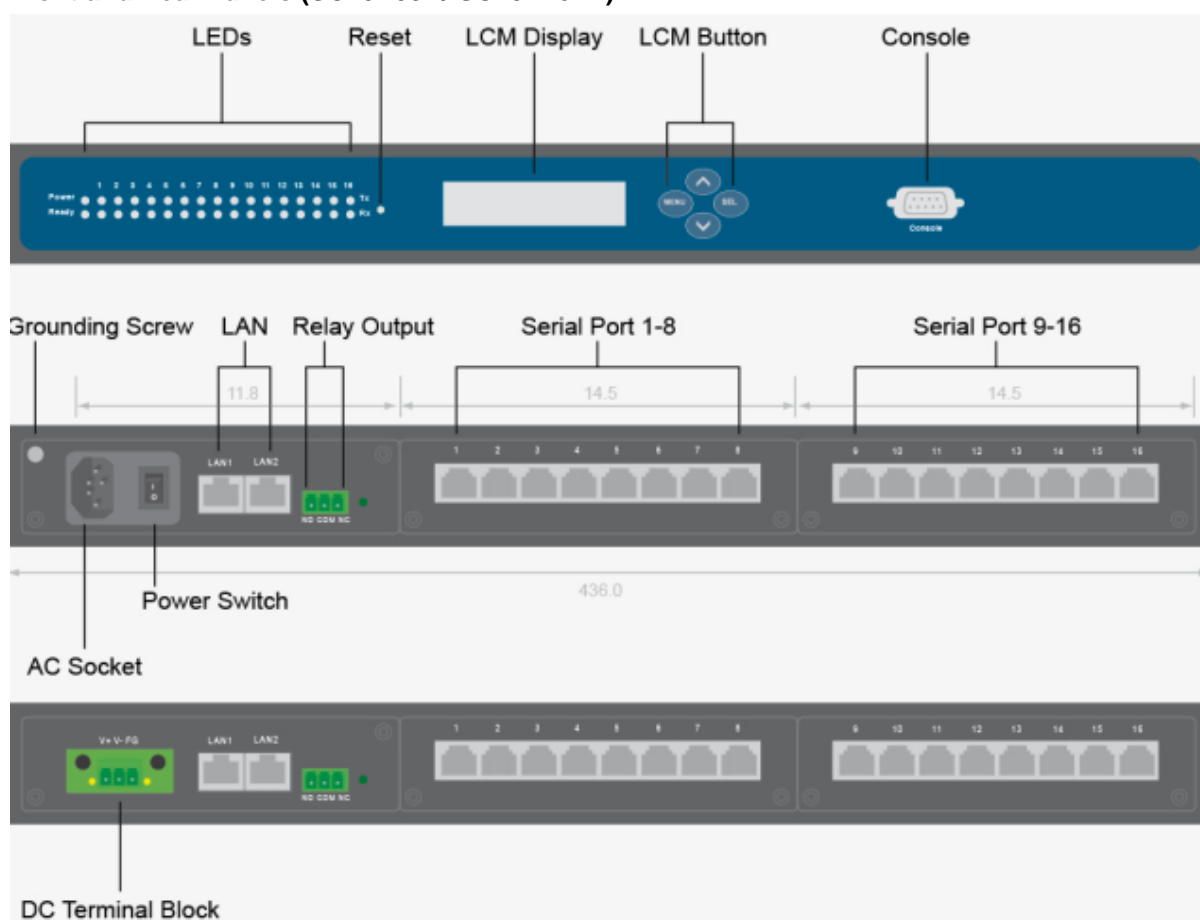

Figure 1

2.4 First Time Installation

Before installing the device, please adhere to all safety procedures described below, SAN will not be held liable for any damages to property or personal injuries resulting from the installation or overall use of the device.

1. Prepare the necessary cables, power cord, LAN cable, serial cable, etc.; **do not connect the unit yet.**
2. Proceed then to plug the power source to the unit.
3. Place the device in the desired location and connect it to the LAN via an Ethernet cable with an RJ45 connector.
4. Connect your computer to the LAN network.

2.5 User Interface Overview

The web configuration appears as follows, Figure . The device can be configured using our Serial Manager utility also, for more information, refer to Serial Manager's manual.

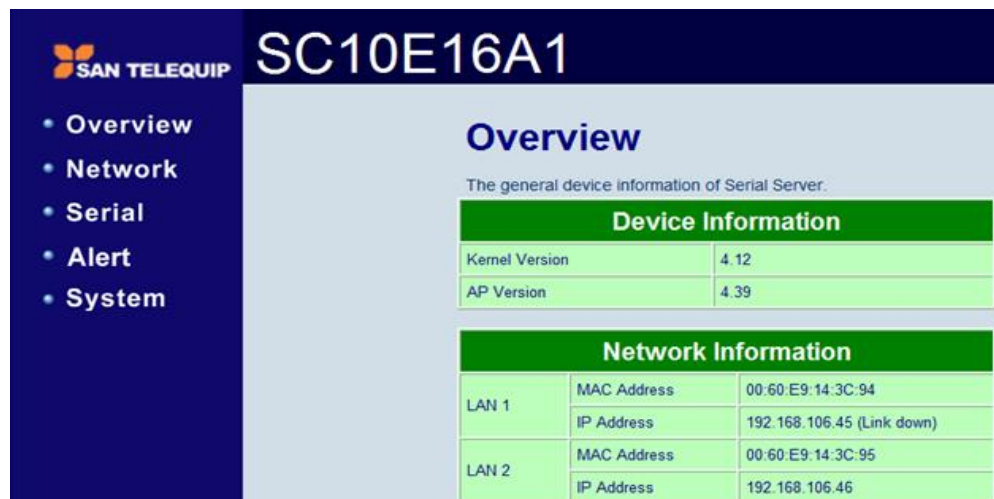

Figure 2

On the left side, a menu-tree appears with all the modes and options available; while on the right side of your screen the contents of each mode/option will be displayed in a graphical state. It is also worth noting that as a first step to view your device's overall settings, you should use Serial Manager© (the utility provided in the CD). There will be however, some buttons which will be present during almost each section.





2.6 Factory Default Settings

Upon arrival, the device will be set as follows:

Parameters		Default Values
LAN 1	IP Address	10.0.50.100
	Gateway	10.0.0.254
	Subnet Mask	255.255.0.0
LAN 2	IP Address	192.168.1.1
	Gateway	192.168.1.254
	Subnet Mask	255.255.255.0
User Name		Admin
Password		null (leave it blank)
COM		RS-232 (RS-422 if RS-232 is unavailable),9600, None, 8,1,No Flow Control
COM Link Mode		Mode: RAW, Type: TCP Server, Listen port 4660, Filter=0.0.0.0

LCM Configuration

There is an LCM (Liquid Crustal Monitor) installed on the front panel of the device that can be used to display device information and perform basic configurations. The table below illustrates its buttons and corresponding functions.

Buttons	Function
	Open Main Menu or go back one level higher
	Scroll up
	Scroll down
	Confirm the selection. When working with IP addresses, pressing <SEL> means moving to the next digit

1.1 Welcome Screen

When the device boots up, the LCM will display LAN1. If you scroll down, it will display LAN2 information. The format is:

```
LAN1: Link down  
10.0.50.100 ▼
```

1.2 Main Menu Structure

Press the <Menu> Key to enter the main menu. Press <Scroll Down> to go to the next layer or option. Press <Scroll Up> to go to the back one layer or option.

1.2.1 Overview

1 st layer	2 nd layer	3rd layer	4 th layer	5 th layer	Descriptions	
1.Overview	1.Model name				Display Model name	
	2.Kernel ver.				Display kernel version	
	3. AP ver.				Display AP version	
	4.Lan 1		1.Lan status			Display LAN1 status
			2.MAC			Display MAC address of LAN1
	5.Lan 2		1.Lan status			Display LAN2 status
2.MAC					Display MAC address of LAN2	

1.2.2 Network Settings

1 st layer	2 nd layer	3rd layer	4 th layer	5 th layer	Descriptions	
2.Network set	1.Lan 1	1.IP config	1.Static IP		Change to Static IP mode	
			2.DHCP		Chang to DHCP mode	
		2.IP address			Display/Change LAN1 IP	
		3.Net mask			Display/Change Net mask	
		4.Gateway			Display/Change the Gateway IP	
		5.ARP Announce			Time Setting in seconds	
	2.Lan 2	1.IP config	1.IP config	1.Static IP		Change to Static IP mode
				2.DHCP		Chang to DHCP mode
		2.IP address			Display/Change LAN2 IP	
		3.Net mask			Display/Change Net mask	
		4.Gateway			Display/Change Gateway IP	
		5.ARP Announce			Time Setting in seconds	
	3.DNS server1				Display/ Change DNS Server 1 IP address	
	4.DNS server2				Display/ Change DNS Server 2 IP address	

1.2.3 Serial Settings

1 st layer	2 nd layer	3rd layer	4 th layer	5 th layer	Descriptions
3.Serial set	1.Select port				Select a COM Port to configure
		1.Baud Rate	2.Parameter set	1. 50	
	2. 75				
	3. 110				
	4. 134				
	5. 150				
	6. 200				
	7. 300				
	8. 600				
	9. 1200				
	10. 2400				
	11. 4800				
	12. 9600				
	13. 19200				
	14. 38400				
	15. 57600				
	16. 115200				
	17. 230400				
	18. 460800				
19. 921600					
	2.Parity	2.Parity	1. None		Display/Change Parity
			2. Odd		
			3. Even		
			4. Mark		
			5.Space		
	3.Data bits	3.Data bits	1. 5 bits		Display/Change Data bit
			2. 6 bits		

			3. 7 bits		
			4. 8 bits		
		4.Stop bits	1. 1 bits		Display/Change Stop bit
			2. 2 bits		
		5.Flow control	1. None		Display/Change Flow control mode
			2. Xon/Xoff		
			3. Hardware		
		6.Delimiter	1.Net to serial	1.Disable	Disable UART Delimiter
				2.Enable	1.Timer: Change UART delimiter to timer mode and set its time
			2.Serial to net		2.Char: Change UART delimiter to character mode and set the character
				1.Disable	Disable UART Delimiter
		7.UART mode	1. 232	2.Enable	1.Timer: Change UART delimiter to timer mode and set its time
					2.Char: Change UART delimiter to character mode and set the character
			2. 422		Display/Change UART mode to RS422
			3. 485		Display/Change UART mode to RS485
		8.Apply to all			
Yes			Apply serial settings to all serial ports		
3.Link mode			Display/Change Link mode		
	1.TCP server	1.Virtual COM	1.Disable	Display/Change Virtual COM mode	
2.Enable					

			2.Local port		Display/Change Local listening port
			3.Max connect		Display/Change maximum client connection (1~4)
			4.IP Filter	1.Disable	Display/Change IP Filter function and the IP address
				2.Enable	
			5. Apply to all	1.No	Apply Link mode Settings to all serial ports
		2.Yes			
		2.TCP client	1.Dest IP 1		Display/Change Destination IP 1
			2.Dest port 1		Display/Change Destination port 1
			3.Destination 2	1.Disable	Disable destination 2
				2.Enable	Display/Change Destination IP 2 and Destination port 2
		4. Apply to all	1.No	Apply Link mode Settings to all serial ports	
			2.Yes		
		3.UDP	1.Local port		Display/Change Local listening port
			2.Dest IP1		Display/Change Destination IP 1
			3.Dest port 1		Display/Change Destination Port 1
4.Destination [2-8]	1.Disable		Disable Destination [2-8]		
	2.Enable		Display/Change Destination IP [2-8] and Destination port [2-8]		
b. Apply to all	1.No		Apply Link mode Settings to all serial ports		
	2.Yes				

1.2.1 Server State

1 st layer	2 nd layer	3rd layer	4 th layer	5 th layer	Descriptions
4.Server state	1.Console	1.Web console	1.Disable		Disable Web console
			2.Enable		Enable Web console
		2.Telnet console	1.Disable		Disable Telnet console
			2.Enable		Enable Telnet console
	2.Pwd protect	1.LCM console	1.No		Disable LCM console password protection
			2.Yes		Enable and change the password
		2.Reset button	1.No		Disable the Reset button password protection
			2.Yes		Enable and change the password on Reset button
	3.Ping	1.Lan 1			Use "ping" command to check specific IP address for LAN1
		2.Lan 2			Use "ping" command to check specific IP address for LAN2

1.2.2 Restart

1 st layer	2 nd layer	3rd layer	4 th layer	5 th layer	Descriptions
5.Restart	1.No				Cancel Restart command
	2.Yes				Restart immediately

3.Web Configuration

3.1 Administrator Login

As soon as the device is connected on the LAN, the user can proceed to navigate through its configuration using **Serial Manager**© utility that comes in the CD Important information such as the IP, MAC address, etc. is going to be displayed.

WIN2012R2 and WIN2016 Supported: TABCTL32.OCX and mswinsck.ocx “files need to copy from CD or download from our Web site : www.santelequip.com /download.

Register the .ocx into OS.

Open command prompt to type following commands.

- regsvr32 c:\windows\system32\TABCTL32.ocx
- regsvr32 c:\windows\system32\mswinsck.ocx.

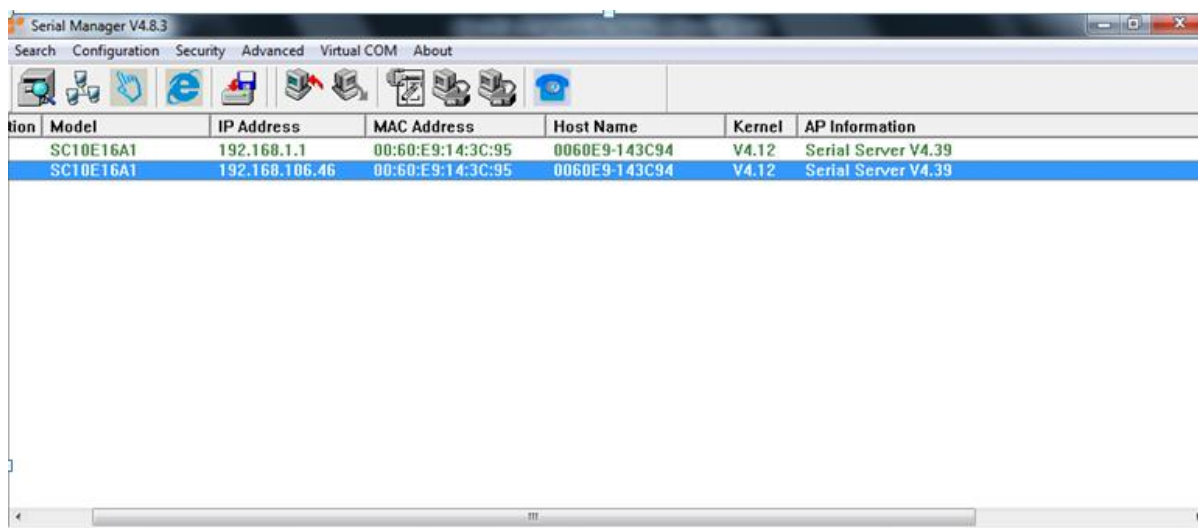

The screenshot shows the Serial Manager V4.8.3 application window. The interface includes a menu bar (Search, Configuration, Security, Advanced, Virtual COM, About) and a toolbar with various icons. Below the toolbar is a table with the following data:

tion	Model	IP Address	MAC Address	Host Name	Kernel	AP Information
	SC10E16A1	192.168.1.1	00:60:E9:14:3C:95	0060E9-143C94	V4.12	Serial Server V4.39
	SC10E16A1	192.168.106.46	00:60:E9:14:3C:95	0060E9-143C94	V4.12	Serial Server V4.39

Figure 3

To access the device's Web UI click on the **Config by browser** icon, the web browser will open and prompt you to enter username and password (see Factory Default Settings for more information), proceed then to click “OK” or press Enter. Alternatively, enter the IP address of the device in the URL bar of the browser.

Note: Be sure your PC is located in the same network sub-net as SC10E08A/ SC10E16A1 Series.

3.2 Overview

This section gives a general status information on Device, network, ERPS and STP.

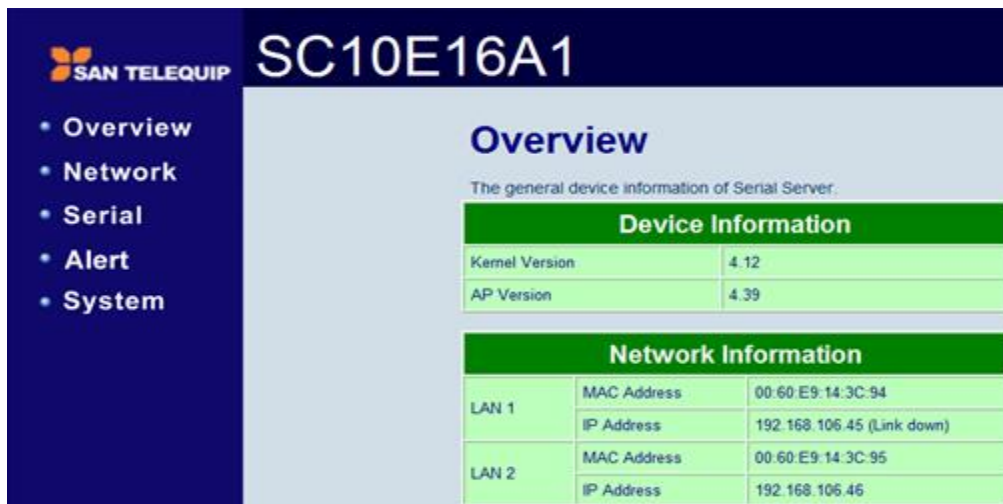

Figure 4

Device Information, displays system Kernel and AP versions.

Device Information	
Kernel Version	4.12
AP Version	4.39

Figure 5

Networking Information, displays both 'LAN1 and LAN 2's information on the overview page. The information provided with networking settings.

The serial server is equipped with two LAN ports and provides two modes of settings,

1. Dual Subnet Mode

Subnet is a logically visible subdivision of an IP network. The LAN 1 and LAN2 can be assigned to different subnets. This feature gives the user flexible network manageability.

2. Redundancy Mode

A goal of **redundant topologies** is to eliminate network downtime caused by a single point of failure. The LAN1 and LAN2 can be assigned to the same IP network. It will enable the network to recover rapidly from failure and fault, so that the failures and faults will be bypassed.

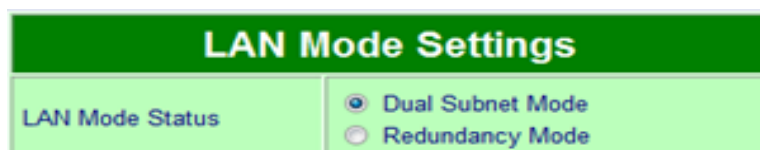
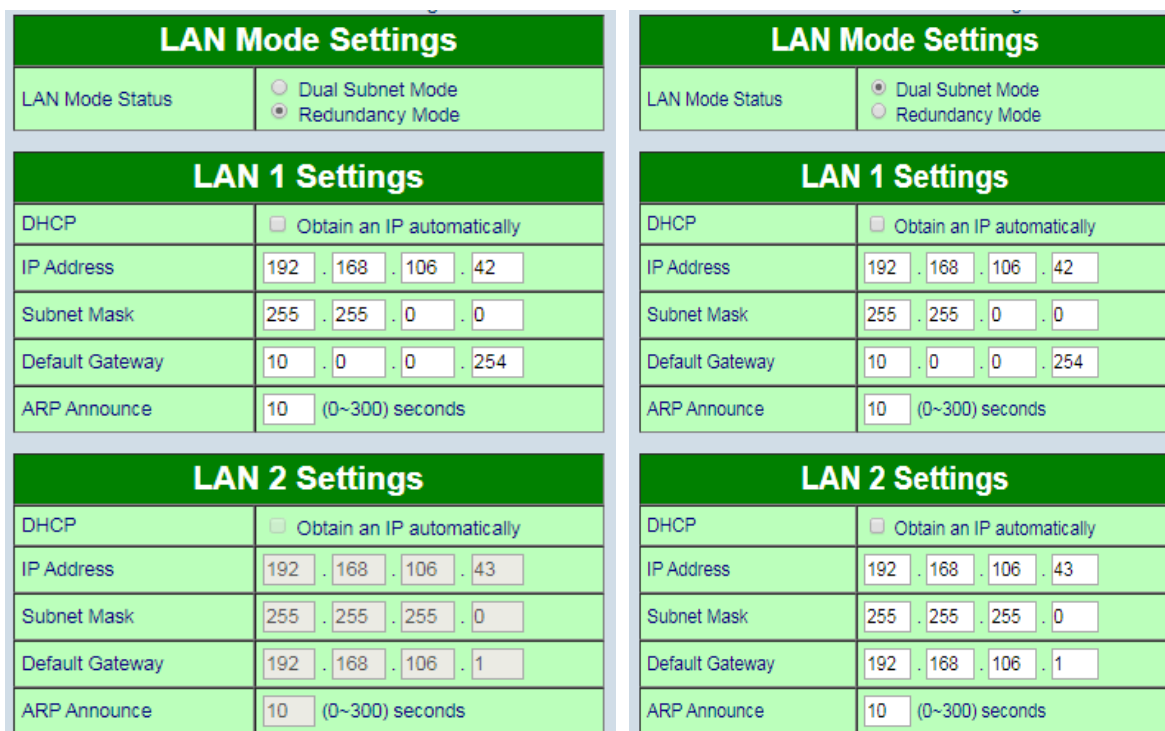

Figure 6

3.3 Network Configuration

Click on the “**Network**” link to open network settings.

- LAN Settings**, when the Redundancy function is enabled, LAN1 and LAN2 will use the same IP address for redundancy, and LAN2 Settings will be disabled. When the Dual Subnet function is enabled, LAN1 and LAN2 can be in different subnets. Fill in LAN settings accordingly. Alternatively, you may activate DHCP (Dynamic Host Configuration Protocol) client function by checking on “**Obtain an IP automatically**” field to obtain IP address, gateway and subnet mask, and DNS from a DHCP server automatically. In addition, You can fill in the time setting for ARP announce.



LAN Mode Settings	
LAN Mode Status	<input type="radio"/> Dual Subnet Mode <input checked="" type="radio"/> Redundancy Mode

LAN 1 Settings	
DHCP	<input type="checkbox"/> Obtain an IP automatically
IP Address	192 . 168 . 106 . 42
Subnet Mask	255 . 255 . 0 . 0
Default Gateway	10 . 0 . 0 . 254
ARP Announce	10 (0~300) seconds

LAN 2 Settings	
DHCP	<input type="checkbox"/> Obtain an IP automatically
IP Address	192 . 168 . 106 . 43
Subnet Mask	255 . 255 . 255 . 0
Default Gateway	192 . 168 . 106 . 1
ARP Announce	10 (0~300) seconds

Figure 7

- DNS Settings** Fill in DNS (Domain Name System) information in order to have an external DNS server resolve domain name into IP address. This is crucial if the NTP and SMTP services use domain names instead of IP addresses. A DNS server will be retrieved from the DHCP server automatically if DHCP is enabled.



DNS Settings	
DNS1	168 . 95 . 1 . 1
DNS2

Figure 8

- SNMP Settings**, The SNMP function is disabled by default. To enable this function check on

“**Enable SNMP**” option. Basic SNMP configurations such as Read/Write Community, SysName (System Name), SysLocation (System Location), and SysContact (System Contact) are supported. In addition, you can send SNMP Trap events to a SNMP Trap server by entering its IP address. The changes will become effective immediately after a successful save.

SNMP Settings	
SysName	<input type="text" value="0060E9-0A9BEE"/>
SysLocation	<input type="text" value="location"/>
SysContact	<input type="text" value="contact"/>
SNMP	<input type="checkbox"/> Enable SNMP
Read Community	<input type="text" value="public"/>
Write Community	<input type="text" value="private"/>
SNMP Trap Server	<input type="text" value="0"/> . <input type="text" value="0"/> . <input type="text" value="0"/> . <input type="text" value="0"/>

Figure 9

3.4 Serial

Click on the “**Serial**” link to open its submenu and COM1 settings.

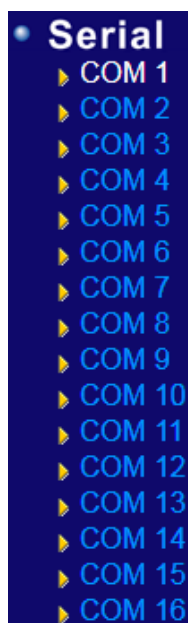
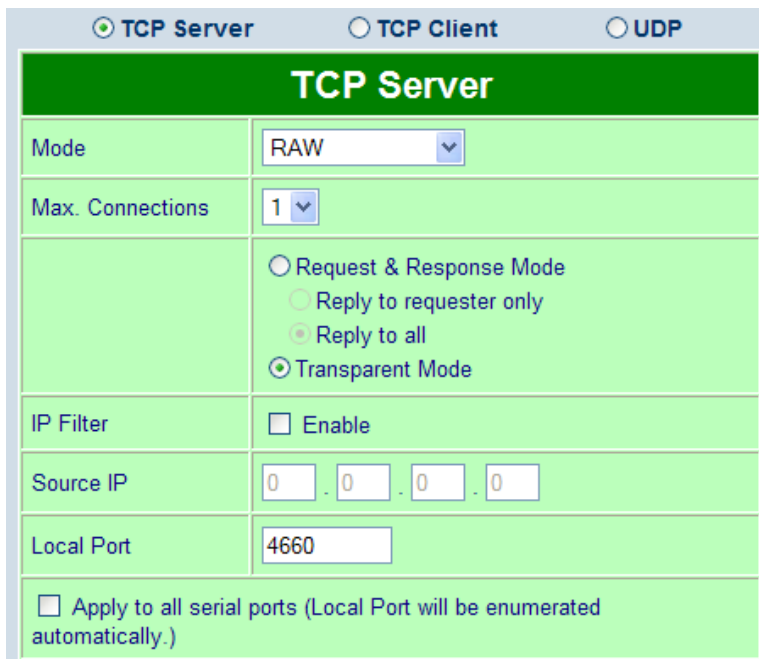

Figure 9

3.4.1 COM Configuration

This section will only focus on the serial settings (Figure 11). Details on connectivity protocols and their settings (Figure) are given in **Link Modes and Applications**.



The screenshot shows a configuration window for a TCP Server. At the top, there are three radio buttons: 'TCP Server' (selected), 'TCP Client', and 'UDP'. Below this is a green header bar with the text 'TCP Server'. The main area contains several fields:

- Mode:** A dropdown menu set to 'RAW'.
- Max. Connections:** A dropdown menu set to '1'.
- Response Mode:** Three radio buttons: 'Request & Response Mode' (unselected), 'Reply to requester only' (unselected), and 'Reply to all' (selected).
- Transparent Mode:** A radio button that is selected.
- IP Filter:** A checkbox labeled 'Enable' which is unchecked.
- Source IP:** Four input boxes, each containing the digit '0', separated by dots.
- Local Port:** An input box containing the number '4660'.
- Apply to all serial ports:** A checkbox which is unchecked, with the text '(Local Port will be enumerated automatically.)' below it.

Figure 10



The screenshot shows a configuration window for Serial Settings. It has a green header bar with the text 'Serial Settings'. The main area contains several fields:

- UART Mode:** Four radio buttons: 'RS232' (unselected), 'RS422' (unselected), 'RS485(2-Wire)' (unselected), and 'RS485(4-Wire)' (selected).
- Baud Rate:** A dropdown menu set to '600' with 'bps' to its right.
- Parity:** Five radio buttons: 'None' (selected), 'Odd' (unselected), 'Even' (unselected), 'Mark' (unselected), and 'Space' (unselected).
- Data bits:** Four radio buttons: '5 bits' (unselected), '6 bits' (unselected), '7 bits' (unselected), and '8 bits' (selected).
- Stop bits:** Two radio buttons: '1 bit' (selected) and '2 bits' (unselected).
- Flow Control:** Three radio buttons: 'None' (selected), 'Xon/Xoff' (unselected), and 'RTS/CTS' (unselected).
- Apply to all serial ports:** A checkbox which is unchecked.

Figure11

Match these settings with your serial device:

- **UART Mode**, Select between RS-232, RS-422, and RS-485.(2-Wire or 4 –Wire)
- **Baud Rate**, Select one of the baud rates from the dropdown box.
- **Parity/Data Bits/Stop Bits**, Configure them accordingly.
- **Flow Control**, Choose between No Flow Control, RTS/CTS (Hardware Flow Control), and Xon/Xoff (Software Flow Control). If Xon/Xoff is selected, Xon and Xoff characters are

changeable. Defaults are 0x11 for Xon and 0x13 for Xoff. If the connecting program or serial device would like to receive the Xon/Xoff signals also, enable “**Permit Xon/Xoff Character Pass Through**”. Enable “**Xon/Xoff Special Control**” to allow synchronization between Xon/Xoff states and DSR/DTR signals.

Note: Check “Apply to all serial ports” to execute these settings through all serial ports.

3.4.2 COM Configuration: Advanced Settings

Click on the “**Advanced Settings**” button to open the dialog (Figure 12).

ADVANCED SETTINGS		
TCP	TCP Timeout	<input checked="" type="checkbox"/> Enable <input type="text" value="3600"/> (1~65535) seconds
Delimiters	Serial to Network Packet Delimiter	<input checked="" type="checkbox"/> Interval timeout <input type="text" value="3"/> (1~30000) ms <input checked="" type="radio"/> Auto(caculate by baudrate) <input type="radio"/> Manual setting <input type="checkbox"/> Discard Bytes <input type="text" value="0"/> within the time interval(1~1024)bytes <input type="checkbox"/> Max. Bytes <input type="text" value="1452"/> (within one packet:1~1452 bytes) <input type="checkbox"/> Character <input type="text" value="0x0d0a"/> ("0x"+ASCII Code, Ex. 0x0d or 0x0d0a) (When enabled, if any of the three options above becomes true, serial data would be transmitted)
	Network to Serial Packet Delimiter	<input type="checkbox"/> Interval timeout <input type="text" value="0"/> (1~30000) ms <input type="checkbox"/> Max. Bytes <input type="text" value="1452"/> (within one packet:1~1452 bytes) <input type="checkbox"/> Character <input type="text" value="0x0d0a"/> ("0x"+ASCII Code, Ex. 0x0d or 0x0d0a)
	Character send interval	<input type="checkbox"/> Enable <input type="text" value="0"/> (1~1000) ms
	Response interval timeout	<input checked="" type="checkbox"/> Enable <input type="text" value="1000"/> (1~60000) ms (Work with Request & Response Mode only)
Serial	Serial FIFO	<input checked="" type="checkbox"/> Enable (Disabling this option at baud rates higher than 115200bps would result in data loss).
	Serial Buffer	<input checked="" type="checkbox"/> Empty serial buffer when a new TCP connection is established
<input type="checkbox"/> Apply to all serial ports		

Figure 12

TCP

➔ **TCP Timeout**, Specify the value in “TCP Timeout” to force SC10E08A/ SC10E16A1 Series

actively close a TCP connection after some specific inactivity time (no packets). The default value for it is 3600 seconds. Disabling this option means SC10E08A/ SC10E16A1 Series would never actively close an established connection.

Delimiters

→ **Serial to Network Packet Delimiter**, Packet delimiter is a way of packing data in the serial communication. It is designed to keep packets in track. SC10E08A/ SC10E16A1 Series provides three types of delimiter: Time Delimiter, Maximum Bytes and Character Delimiter. Note that the following delimiters (Interval, Max Byte and Character) are programmed in the OR logic. Meaning that if any of the three conditions were met, SC10E08A/ SC10E16A1 Series would transmit the serial data in its buffer over the network.

- **Interval timeout**, SC10E08A/ SC10E16A1 Series will transmit the serial data in its buffer when the specified time interval has reached and no more serial data comes in. The default value is calculated automatically based on the baud rate. If the automatic value results in chopped data, the timeout could be increased manually by switching to “Manual setting” and specifying a larger value. If the bytes do not reach certain length condition, the bytes could be discard to avoid devices connect on the TCP side running into issues. To do this, enable “**Discard Byte**”, then select the condition (>, <, =, !=) you want and the length desired.

Attention

Interval Timeout Manual Calculation

The optimal “Interval timeout” depends on the application, but it must be at least larger than one character interval within the specified baud rate. For example, assuming that the serial port is set to 1200 bps, 8 data bits, 1 stop bit, and no parity. In this case, the total number of bits needed to send a character is 10 bits, and the time required to transfer one character is $(10 \text{ (bits)}/1200 \text{ (bits/s)}) * 1000 \text{ (ms/s)} = 8.3 \text{ ms}$.

Therefore, you should set the “Interval timeout” to be larger than 8.3 ms. Rounding 8.3 ms to the next integer would get you 9 ms.



- **Max Byte**, SC10E08A/ SC10E16A1 Series will transmit the serial data in its buffer when the specified length has reached. Enable this option if you would like SC10E08A/ SC10E16A1 Series to queue the data until it reaches a specific length. This option is disabled by default.
- **Character**, SC10E08A/ SC10E16A1 Series will transmit the serial data in its buffer when it sees the incoming data include the specified character (in HEX format). This field allows one or two characters. If character delimiter is set to 0x0d, SC10E08A/ SC10E16A1 Series

will push out its serial buffer when it sees 0x0d (carriage return) in the serial data. This option is disabled by default.

- ➔ **Network to Serial Packet Delimiter**, Same as the delimiters above, but controls data flow in the opposite direction. It will store data from the network interface in the queue and send it over to the serial interface until one of the delimiter conditions is met.

- ➔ **Character Send Interval**, This option specifies the time gap between each character. When set to two seconds, SC10E08A/ SC10E16A1 Series will split the data in the queue and only transmit one character (byte) every two seconds; this option is disabled by default.

- ➔ **Response Interval Timeout**, This option only affects the Request & Response Mode and has no effect on the Transparent Mode. When TCP data is received (request) and passed to Serial side, the device will wait for the set time before transferring another TCP data if the Serial side did not receive any data (response).

- ➔ **Serial FIFO**, By default, SC10E08A/ SC10E16A1 Series has its FIFO function enabled to optimize its serial performance. In some applications (particularly when the flow control is enabled), it may deem necessary to disable the FIFO function to minimize the amount of data that is transmitted through the serial interface after a flow off event is triggered to reduce the possibility of overloading the buffer inside the serial device. Please note that disabling this option on baud rates higher than 115200bps would reduce the data integrity noticeably.

- ➔ **Serial Buffer**, By default, SC10E08A/ SC10E16A1 Series will empty its serial buffer when a new TCP connection is established. This means that the TCP application will not receive buffered serial data during a TCP link breakage. To keep the serial data when there is no TCP connection and send out the buffered serial data immediately after a TCP connection is established, disable this option.

3.5 Alert Settings



Click on the **“Alert”** link to open its submenu and E-mail settings.

Figure 13

3.5.1 Email Settings

In case the device raises an alert and/or warning message, it will send an email to the administrator’s mailbox. **Email Settings** allows you to set up the device to be able to send an email. To set up the

email sending, you need to put a **“Sender”** email address which will be the **“From”** on the email. Then, you fill in **“Receiver”** email address to which the email is sent. You can send the email to several recipients using Semicolon (;) to separate each email address. Next step is to set the **Email Server**. First, you fill in the **IP address** of a **Mail Server** in your local network. If the **Mail Server** needs a user authentication, you need to enable **“SMTP server authentication required”**, and fill in **Username** and **Password**. Please contact your network administrator for **Mail Server IP address** and the **Username** and **Password**,

Note: You can click on the “Send test Mail” button to verify your mail settings.

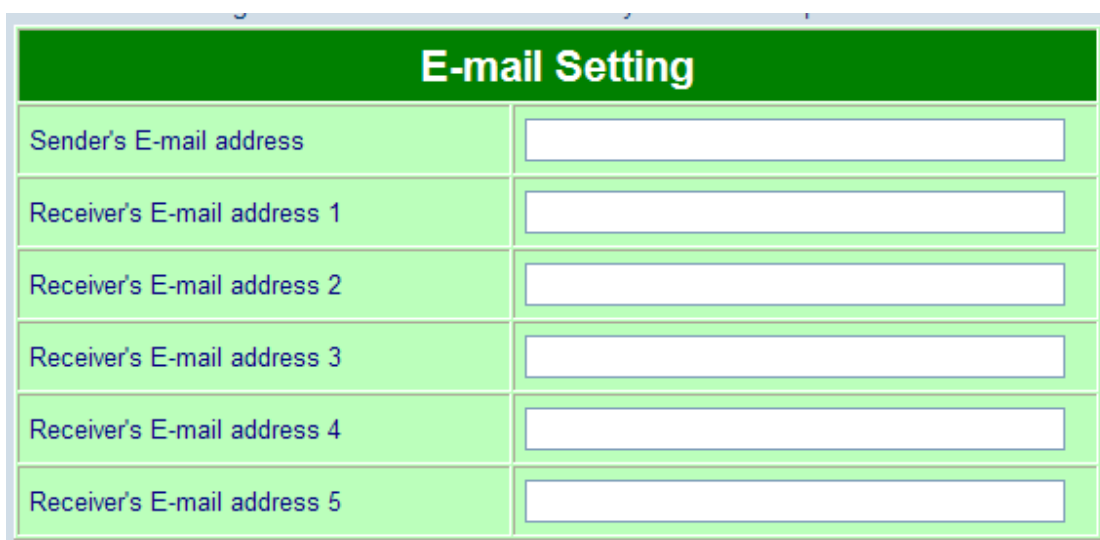

E-mail Setting	
Sender's E-mail address	<input type="text"/>
Receiver's E-mail address 1	<input type="text"/>
Receiver's E-mail address 2	<input type="text"/>
Receiver's E-mail address 3	<input type="text"/>
Receiver's E-mail address 4	<input type="text"/>
Receiver's E-mail address 5	<input type="text"/>

Figure 14

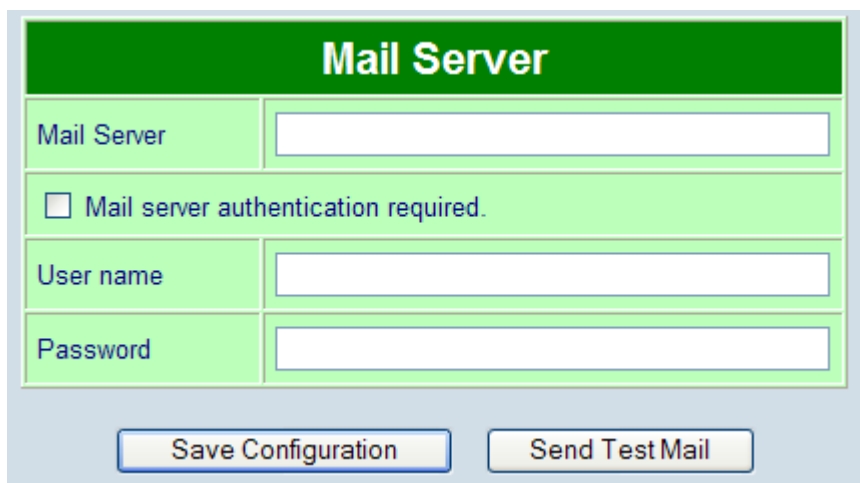

Mail Server	
Mail Server	<input type="text"/>
<input type="checkbox"/> Mail server authentication required.	
User name	<input type="text"/>
Password	<input type="text"/>

Figure 15



Attention

It is also important to setup Default Gateway and DNS Servers in the Network Settings properly, so your SC10E08A/ SC10E16A1 Series can lookup DNS names and route the mails to the proper default gateway.

3.5.2 Alert Event

Events could be triggered in different ways. Including Cold Start, Warm Start, Authentication Failure, IP Change, Password Change, and Link Down. SC10E08A/ SC10E16A1 Series supports three different types of event alerts, which are E-mail, SNMP Trap, and Relay.

Alert Event

To configure the SE series to send alert by E-mail or trap.

Alert Event		
Cold Start	<input type="checkbox"/> E-mail	<input type="checkbox"/> Trap
Warm Start	<input type="checkbox"/> E-mail	<input type="checkbox"/> Trap
Authentication Failure	<input type="checkbox"/> E-mail	<input type="checkbox"/> Trap
IP Address Changed	<input type="checkbox"/> E-mail	
Password Changed	<input type="checkbox"/> E-mail	
LAN1 Link Down	<input type="checkbox"/> Relay ON	
LAN2 Link Down	<input type="checkbox"/> Relay ON	

Figure 16

3.6 System Configuration

Click on the **“System”** link to open its submenu and this will lead you to the Link State.

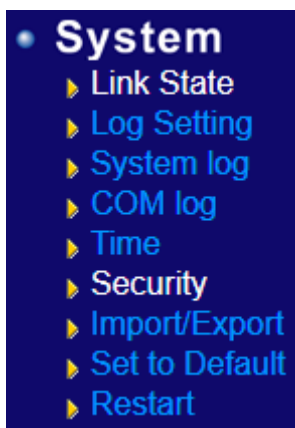

Figure 17

3.6.1 Link State

Link State displays the information of each connection for all serial ports for debugging purposes. It also displays the byte count of each serial port's Transmit (Tx) and Receive (Rx) data.

Link State													
Com	Link Mode	TX	RX	TX Total	RX Total	IP1	IP2	IP3	IP4	IP5	IP6	IP7	IP8
1	TCP Server	0	0	0	0	Listen							
2	TCP Server	0	0	0	0	Listen							
3	TCP Server	0	0	0	0	Listen							
4	TCP Server	0	0	0	0	Listen							
5	TCP Server	0	0	0	0	Listen							
6	TCP Server	0	0	0	0	Listen							
7	TCP Server	0	0	0	0	Listen							
8	TCP Server	0	0	0	0	Listen							
9	TCP Server	0	0	0	0	Listen							
10	TCP Server	0	0	0	0	Listen							

Figure 24

Serial State					
Com	UART Mode	Baud Rate	Parity	Data bits	Stop bits
1	RS-232	115200bps	None	8 bits	1 bits
2	RS-232	115200bps	None	8 bits	1 bits
3	RS-232	115200bps	None	8 bits	1 bits
4	RS-232	115200bps	None	8 bits	1 bits
5	RS-232	115200bps	None	8 bits	1 bits
6	RS-232	115200bps	None	8 bits	1 bits
7	RS-232	115200bps	None	8 bits	1 bits
8	RS-232	115200bps	None	8 bits	1 bits
9	RS-422	115200bps	None	8 bits	1 bits
10	RS-422	115200bps	None	8 bits	1 bits
11	RS-422	115200bps	None	8 bits	1 bits
12	RS-422	115200bps	None	8 bits	1 bits
13	RS-422	115200bps	None	8 bits	1 bits
14	RS-422	115200bps	None	8 bits	1 bits
15	RS-422	115200bps	None	8 bits	1 bits
16	RS-422	115200bps	None	8 bits	1 bits

Figure 25

3.6.2 Log Settings

The Syslog function is turned on by default and cannot be turned off. It is used to log system events and report to an external Syslog server if necessary. Also, Transmitted data could be logged for recording or debugging purposes. The logs could be reported to an external Syslog server as well.

System Log Setting	
Enable Log Event to Flash	<input type="checkbox"/>
Log Level	3: (LOG_ERR) ▾
Enable Syslog Server	<input type="checkbox"/>
Syslog Server IP	0 . 0 . 0 . 0
Syslog Server Service Port	514 (1~65535, default=514)

Figure 26

System Log Settings

- **Enable Log Event to Flash**, this would write log events to the local flash, otherwise the logs would be cleared when the device restarts because they are stored in the RAM by default.
- **Log Level**, 3 (We only allow logging at this level).
- **Enable Syslog Server**, enabling this option would allow you to send Syslog events to a remote Syslog server.
- **Syslog Server IP**, please specify the remote Syslog Serve IP.
- **Syslog Server Service Port**, please specify the remote Syslog Server Port.

COM Log Settings				
<input type="checkbox"/> Log Data Contents				
Types <input checked="" type="radio"/> HEX <input type="radio"/> ASCII				
Com Ports	<input type="checkbox"/> Com1	<input type="checkbox"/> Com2	<input type="checkbox"/> Com3	<input type="checkbox"/> Com4
	<input type="checkbox"/> Com5	<input type="checkbox"/> Com6	<input type="checkbox"/> Com7	<input type="checkbox"/> Com8
	<input type="checkbox"/> Com9	<input type="checkbox"/> Com10	<input type="checkbox"/> Com11	<input type="checkbox"/> Com12
	<input type="checkbox"/> Com13	<input type="checkbox"/> Com14	<input type="checkbox"/> Com15	<input type="checkbox"/> Com16
Enable Syslog Server	<input type="checkbox"/>			
Syslog Server IP	0 . 0 . 0 . 0			
Syslog Server Service Port	514 (1~65535, default=514)			

Figure 27

COM Log Settings

- **Log Data Contents**, if enabled, the COM logging function will log the content (raw bytes) of data that is being transmitted and received. If disabled, COM logging function will only log data length

to reduce system load.

Note:SC10E08A/ SC10E16A1 Series can store up to 1500 lines internally. A request or a response will consist of one line, data longer than 512 bytes will go into another line. You can retrieve the logs by using a FTP Client. FTP login is the same as the WebUI. They are located in /var/log/logcomxx (xx is the port number).When the reserved space is full, new logs will replace old logs. We strongly recommend sending COM logs to a remote Syslog server.

- **Data Log Types**, Hex or ASCII.
- **COM x**, choose which port to log.
- **Enable Syslog Server**, enabling this option will allow you to send COM logs to a remote Syslog server. You can send COM logs to the same Syslog server used previously for logging events.
- **Syslog Server IP**, please specify the remote Syslog Server IP.
- **Syslog Server Service Port**, please specify the remote Syslog Server Port.

3.6.3 System Log

Display the current syslog stored in the device.

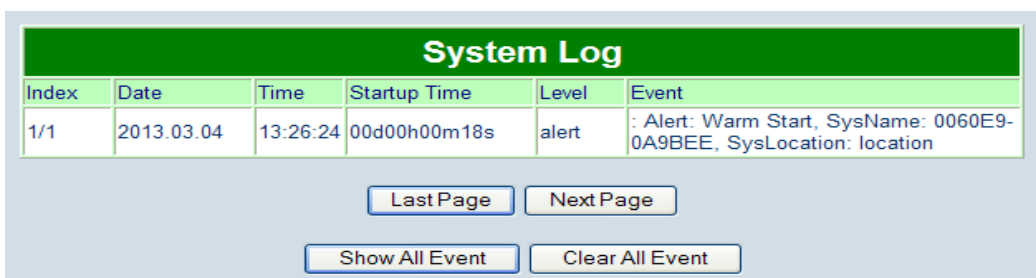

Figure 28

Click on “Last Page” to go to the last page. Click on “Show All Event” to show all events in one page. Click on “Clear All Event” to clear the events stored in the device.

3.6.4 COM Log

You can select from the COMx dropdown box to display logs from different COM ports. The first three lines were set to show the logging of data length and the last two lines were set to show data content in Hexadecimal.

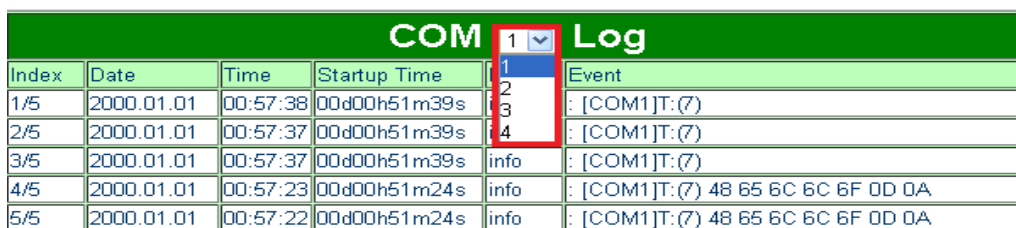



Figure 29

Click on "Last Page" to go to the last page. Click on "Show All Event" to show all events in one page.
 Click on "Clear All Event" to clear the events stored in the device.

3.6.5 Time Settings

Date and time can be set manually, or using **Network Time Protocol (NTP)** to automatically synchronizes with a Time Server. For auto-synching select **NTP** in the **Time Setting** field, proceeding then to fill the IP address or hostname for it. If a hostname is entered, the DNS server must be configured properly; a Time Zone can be selected as well.

	<p>Attention</p> <p>It is also important to setup Default Gateway and DNS Servers in the Network Settings properly, so your SC10E08A/ SC10E16A1 Series can lookup DNS names and find the external NTP Server.</p>
---	--

In case that you are located in a region where **Daylight Saving Time (DST)** is being used, enable this option and setup the start and end date when DST will become effective. Also enter the time that DST offsets (usually one hour).

Current System Time	
2013/3/4 Mon 13:39:22	Refresh

System Time Setting	
Time Zone	(GMT+05:30) Bombay, Calcutta, Madras, New Delhi
Time Setting	<input type="radio"/> NTP <input checked="" type="radio"/> Manual
NTP Setting	
NTP Server	time.nist.gov
Manual Setting	
Date	Year: 2013 / Month: Mar / Day: 4
Time	Hour:(0~23) : 13 Minute:(0~59) : 39 Second:(0~59) : 22
Daylight Saving Setting	
<input type="checkbox"/> Enable Daylight Saving Time	
Start Date	Month: Jan / Week: 1st / Day: Sun / Hour: 1
End Date	Month: Jan / Week: 1st / Day: Sun / Hour: 1
Offset	1 hour(s)

Figure 30

3.6.6 Security Configuration

Change Password	
Old Password	<input type="text"/>
New Password	<input type="text"/>
Verified Password	<input type="text"/>

Figure 31

Change Password

Enter the old password in the “**Old Password**” field; enter the new password in the “**New Password**” and the “**Verified Password**” fields, and then click on “**Save Configuration**” to update the password.

Note: You can press the reset button on the device to reset the password to its default value (blank), in case it is forgotten. This will however, erase all the data/settings previously in the device so remember to always save it.

Security	
Web Console	<input checked="" type="radio"/> Enable <input type="radio"/> Disable
Telnet Console	<input checked="" type="radio"/> Enable <input type="radio"/> Disable
LCM Password Protect	<input checked="" type="radio"/> No <input type="radio"/> Yes
Reset Button Protect	<input checked="" type="radio"/> No <input type="radio"/> Yes

Figure 32

Security

You can disable certain access methods to reduce the risk of system intrusion. This includes the Web UI, Telnet console, LCM, and the Reset Button.

Web Console– Disable to prevent the Web UI from being accessed.

Telnet Console – Disable to prevent the Telnet console from be accessed.

LCM Password Protect – LCM will prompt for a password before the device can be configured through the LCM when it is protected. Press the “Up” and “Down” buttons next to the LCM to select the characters one by one.

Reset Button Protect –Resetting the device back to the defaults becomes impossible when the reset button is protected.

3.6.7 Import/Export

Once all the configurations are set and the device is working properly, you may want to back up your configuration. Backup can be used when the new firmware is uploaded and it is reset to a factory default settings, it is done to prevent accidental loading of incompatible old settings. The backup file could also be used to efficiently deploy multiple SC10E08A/ SC10E16A1 Series of similar settings by uploading these settings to the devices.

To backup your configuration, click “**Export Configuration**”, and a pop-up dialog is prompted for saving the backup file on your computer. It is important **NOT to modify the saved configuration file by any editor. Any modification to the file may corrupt the file, it may not be used for restore.**

To restore the configuration backup, click “**Browse**” to locate the backup file, and then click “**Import Configuration**” to upload the configuration backup file to the device. Once, the backup file is successfully uploaded; the device will restart, the time needed for this process may vary on the equipment used.

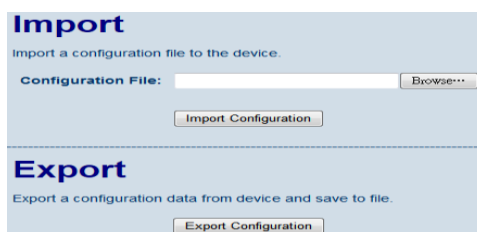

Figure 33

3.6.8 Set to Default

Click on “**Set to Default & Restart**” button to restore the device’s settings to Factory Default Settings.



Figure 34

3.6.9 Restart

Click on the “**Restart**” button to restart the device. The web page will refresh after the device complete the reboot.

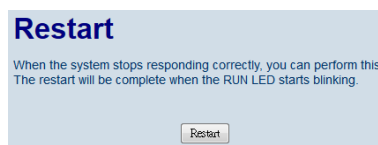

Figure 35

CLI Configuration

3.7 Accessing the CLI

SC10E08A/ SC10E16A1 Series can be configured by CLI (Command-Line Interface). There are two ways to access the CLI. Both methods will lead to the same CLI, i.e., a command line interface that allows you to modify most settings in your device.

3.7.1 Serial Console

The console interface follows standard RS-232 specification, find pin assignments in [Section 6.3.2](#). The interface can be accessed with the following settings:

Baud rate	115200bps
Parity	None
Data bits	8 bits
Stop bit	1 bit
Flow Control	None

3.7.2 Telnet Console

Please be aware that Windows Vista / Windows 7 or higher do not have Telnet client installed by default, to install Microsoft Telnet client on these systems:

1. Click **Start**, and then click **Control Panel**.
2. On the **Control Panel** Home page, click **Programs**.
3. In the Programs and Features section, click Turn Windows features on or off.
4. If the **User Account Control** dialog box appears, confirm that the action it displays is what you want, and then click **Continue**.
5. In the **Windows Features** list, select **Telnet Client**, and then click **OK**, Figure .

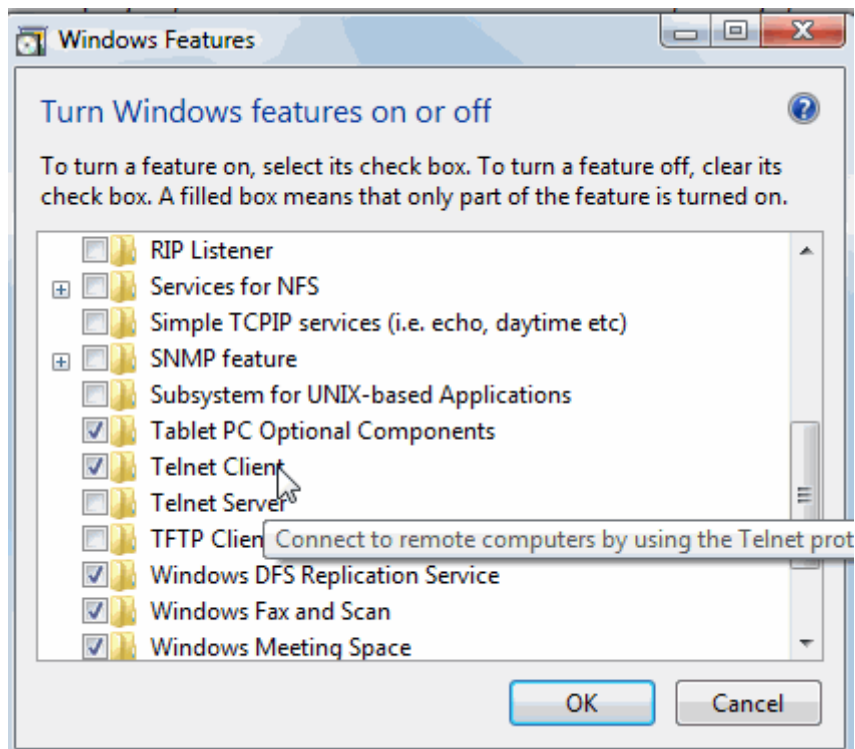

Figure 36

3.8 General Information

Open the command line interface (console terminal) and telnet to the device using its IP address. The default username is “admin” and password is empty (blank). A main menu should appear, Figure 36.







Figure 37

Note:

1. SC10E08A/ SC10E16A1 Series will automatically close the telnet connection after three minute of inactivity.
2. Press the “ESC” key to return to the previous menu.
3. Some changes to the device would take effect only after the device is restarted.

4. Detailed explanations are available in the **LCM Configuration**

There is an LCM (Liquid Crustal Monitor) installed on the front panel of the device that can be used to display device information and perform basic configurations. The table below illustrates its buttons and corresponding functions.

Buttons	Function
	Open Main Menu or go back one level higher
	Scroll up
	Scroll down
	Confirm the selection. When working with IP addresses, pressing <SEL> means moving to the next digit

1.3 Welcome Screen

When the device boots up, the LCM will display LAN1. If you scroll down, it will display LAN2 information. The format is:

```
LAN1: Link down
10.0.50.100 ▼
```

1.4 Main Menu Structure

Press the <Menu> Key to enter the main menu. Press <Scroll Down> to go to the next layer or option. Press <Scroll Up> to go to the back one layer or option.

1.4.1

1.4.2

1.4.3

1.4.4

1.4.5 Overview

1st layer	2nd layer	3rd layer	4th layer	5th layer	Descriptions	
1.Overview	1.Model name				Display Model name	
	2.Kernel ver.				Display kernel version	
	3. AP ver.				Display AP version	
	4.Lan 1		1.Lan status			Display LAN1 status
			2.MAC			Display MAC address of LAN1
	5.Lan 2		1.Lan status			Display LAN2 status
			2.MAC			Display MAC address of LAN2

1.4.6 Network Settings

1st layer	2nd layer	3rd layer	4th layer	5th layer	Descriptions
2.Network set	1.Lan 1	1.IP config	1.Static IP		Change to Static IP mode
			2.DHCP		Chang to DHCP mode
		2.IP address			Display/Change LAN1 IP
		3.Net mask			Display/Change Net mask
		4.Gateway			Display/Change the Gateway IP
		5.ARP Announce			Time Setting in seconds
		2.Lan 2	1.IP config	1.Static IP	
	2.DHCP				Chang to DHCP mode
	2.IP address				Display/Change LAN2 IP
	3.Net mask				Display/Change Net mask
	4.Gateway				Display/Change Gateway IP
	5.ARP Announce			Time Setting in seconds	
	3.DNS server1				Display/ Change DNS Server 1 IP address
	4.DNS server2				Display/ Change DNS Server 2 IP address

Serial Settings

1st layer	2nd layer	3rd layer	4th layer	5th layer	Descriptions
3.Serial set	1.Select port				Select a COM Port to configure
	2.Parameter set	1.Baud Rate	1. 50		Display/Change baud rate
			2. 75		
			3. 110		
			4. 134		
			5. 150		
			6. 200		
			7. 300		
			8. 600		
			9. 1200		
			10. 2400		
			11. 4800		
			12. 9600		
			13. 19200		
			14. 38400		
			15. 57600		
			16. 115200		
			17. 230400		
			18. 460800		
19. 921600					
	2.Parity	1. None		Display/Change Parity	
		2. Odd			
		3. Even			
		4. Mark			
		5.Space			

		3.Data bits	1. 5 bits		Display/Change Data bit
			2. 6 bits		
			3. 7 bits		
			4. 8 bits		
		4.Stop bits	1. 1 bits		Display/Change Stop bit
			2. 2 bits		
		5.Flow control	1. None		Display/Change Flow control mode
			2. Xon/Xoff		
			3. Hardware		
		6.Delimiter	1.Net to serial	1.Disable	Disable UART Delimiter
				2.Enable	1.Timer: Change UART delimiter to timer mode and set its time 2.Char: Change UART delimiter to character mode and set the character
			2.Serial to net	1.Disable	Disable UART Delimiter
				2.Enable	1.Timer: Change UART delimiter to timer mode and set its time 2.Char: Change UART delimiter to character mode and set the character
		7.UART mode	1. 232		Display/Change UART mode to RS232
			2. 422		Display/Change UART mode to RS422
			3. 485		Display/Change UART mode to RS485
8.Apply to all					
	Yes		Apply serial settings to all serial ports		

	3.Link mode	1.TCP server			Display/Change Link mode
			1.Virtual COM	1.Disable 2.Enable	Display/Change Virtual COM mode
			2.Local port		Display/Change Local listening port
			3.Max connect		Display/Change maximum client connection (1~4)
			4.IP Filter	1.Disable	Display/Change IP Filter function and the IP address
				2.Enable	
			5. Apply to all	1.No	Apply Link mode Settings to all serial ports
				2.Yes	
			2.TCP client	1.Dest IP 1	Display/Change Destination IP 1
				2.Dest port 1	Display/Change Destination port 1
		3.Destination 2		1.Disable	Disable destination 2
				2.Enable	Display/Change Destination IP 2 and Destination port 2
		4. Apply to all		1.No	Apply Link mode Settings to all serial ports
				2.Yes	
		3.UDP	1.Local port	Display/Change Local listening port	
			2.Dest IP1	Display/Change Destination IP 1	
			3.Dest port 1	Display/Change Destination Port 1	
			4.Destination [2-8]	1.Disable	Disable Destination [2-8]
				2.Enable	Display/Change Destination IP [2-8] and Destination port [2-8]
			b. Apply to	1.No	

			all	2.Yes	Apply Link mode Settings to all serial ports
--	--	--	-----	-------	--

1.4.7 Server State

1st layer	2nd layer	3rd layer	4th layer	5th layer	Descriptions
4.Server state	1.Console	1.Web console	1.Disable		Disable Web console
			2.Enable		Enable Web console
		2.Telnet console	1.Disable		Disable Telnet console
			2.Enable		Enable Telnet console
	2.Pwd protect	1.LCM console	1.No		Disable LCM console password protection
			2.Yes		Enable and change the password
		2.Reset button	1.No		Disable the Reset button password protection
			2.Yes		Enable and change the password on Reset button
	3.Ping	1.Lan 1			Use "ping" command to check specific IP address for LAN1
		2.Lan 2			Use "ping" command to check specific IP address for LAN2

Restart

1st layer	2nd layer	3rd layer	4th layer	5th layer	Descriptions
5.Restart	1.No				Cancel Restart command
	2.Yes				Restart immediately

1.4.8

3.Web Configuration chapter; please refer to the respective sections.

This system overview window gives the general information on Ethernet, MAC address, kernel and AP version.

Operation: Main → [1] Overview

```
-----
Main Menu
-----
[0]EXIT
[1]Overview
[2]Networking
[3]COM Port Settings
[4]Alert Settings
[5]System
[8]Set to Default
[9]Restart
:1
-----
Overview
-----
Model Name           : SC10E16A1
Lan 1 IP Address     : 192.168.106.023
Lan 2 IP Address     : 192.168.001.001 <Link down>
Lan 1 MAC            : 00.60.E9.0A.9B.EE
Lan 2 MAC            : 00.60.E9.0A.9B.EF
Kernel Version       : 1.0
AP Version           : 1.4
Spanning Tree Status : Disabled
-----
[0]EXIT
-----
```

Figure 38

3.9 Networking Configuration

This section allows you to change IP address, subnet mask, gateway, and SNMP information. Please note that the new settings will not take effect until the device is restarted.

Operation: Main → [2]Networking

```
-----
Networking
-----
[0]EXIT
[1]LAN 1 Settings
[2]LAN 2 Settings
[3]DNS Settings
[4]SNMP Settings
[5]Bridge Settings
[6]ERPS Settings
[7]STP Settings
:
-----
```

Figure 39

3.9.1 LAN1 / LAN 2 Settings

Enter “LAN settings” and you will see a menu to configure the DHCP, IP address, subnet mask, and gateway of that LAN.

Operation: Main → [2] Networking → [1] LAN 1 Settings;

Operation: Main → [2] Networking → [2] LAN 2 Settings

```
LAN 1 Settings
-----
[0]EXIT
[1]DHCP      :Disable(Static)
[2]IP        :192.168.106.023
[3]Netmask   :255.255.255.000
[4]Gateway   :192.168.106.050
:
```

Figure 40

Note: It is not possible to configure LAN1 or LAN2 when bridge mode is enabled. Please go to the Bridge Settings instead.

3.9.2 DNS Settings

You can configure the DNS1 or DNS2 Server IP Address manually. Alternatively, if you enable the DHCP option in “**LAN 1 Settings**”, SC10E08A/ SC10E16A1 Series will retrieve the DNS server address from the DHCP server automatically.

Operation: Main → [2]Networking → [3]DNS Settings

```
DNS Settings
-----
[0]EXIT
[1]DNS1      :168.095.001.001
[2]DNS2      :210.062.128.001
:
```

Figure 01

SNMP Settings

SC10E08A/ SC10E16A1 Series allows the user to Enable or Disable the SNMP function. The changes will become effective immediately. Basic SNMP configurations such as Read/Write Community, SysName (System Name), SysLocation (System Location), SysContact (System Contact), and SNMP Trap Server IP are supported.

Operation: Main → [2]Networking → [4]SNMP Settings

```
SNMP Settings
-----
[0]EXIT
[1]SNMP      : Disable
[2]Read Community : public
[3]Write Community : private
[4]SysName    : 0060E9-0A9BEE
[5]SysLocation : location
[6]SysContact : contact
[7]SNMP Trap Server : 000.000.000.000
:
```

Figure 02

3.9.3 Redundancy Settings

SC10E08A/ SC10E16A1 Series has a Redundancy mode that can be enabled. When the Redundancy mode is enabled, LAN1 and LAN2 would be merged to create one single Ethernet interfaces. When one of the physical LAN port fails, SC10E08A/ SC10E16A1 would automatically use the other LAN port. Configure network settings of the bridge here.

Operation: Main → [2]Networking → [6]Redundancy Settings

```
-----  
Bridge Settings  
-----  
[0]EXIT  
[1]Bridge mode:Disable  
[2]DHCP      :Disable(Static)  
[3]IP       :192.168.106.023  
[4]Netmask  :255.255.255.000  
[5]Gateway  :192.168.106.050  
:
```

Figure 43

3.10 COM Port Configuration

SC10E08A/ SC10E16A1 Series allows you to configure the parameters of the COM port including COM Link mode and COM port parameters. First enter the number of the COM port that you want to configure.

```
-----  
COM Port Settings  
-----  
COM port number<Port Number:1~16, 0:exit>  
:1  
-----  
COM1 Port Settings  
-----  
[0]EXIT  
[1]Link Mode  : TCP Server  
[2]Com Setting : RS232,9600,n,8,1  
:
```

Figure 44

3.10.1 TCP Server for Link Mode

TCP Server mode is the default Link Mode for SC10E08A/ SC10E16A1 Series. A TCP Client is required to connect to this TCP Server. You will need to configure **Virtual COM, Max Connections, IP Filter, and Local Port** settings.

Operation: Main → [3]COMPort Setting → [1-16]Select Port → [1]Link Mode → [1]TCP Server

```
-----  
TCP Server <COM1>  
-----  
[0]EXIT  
[1]Virtual COM      : Disable  
[2]Max Connections : 1  
[3]IP Filter       : Disable  
[4]Local Port      : 4660  
:
```

Figure 45

3.10.2 TCP Client for Link Mode

SC10E08A/ SC10E16A1 Series' Link Mode can be configured as a TCP Client. In this case, SC10E08A/ SC10E16A1 Series will connect to a TCP Server. You will need to configure the settings for **Destination IP** 1 and 2 (if enabled).

Operation: Main → [3]COM Port Setting → [1-16]Select Port → [1]Link Mode → [2]TCP Client

```
-----  
TCP Client <COM1>  
-----  
[0]EXIT  
[1]Destination IP 1      : 000.000.000.000  
[2]Destination Port 1   : 4660  
[3]Destination 2       : Disable  
:  
:
```

Figure 47

3.10.3 UDP Link Mode

SC10E08A/ SC10E16A1 Series' Link Mode can be configured to utilize UDP. Note that UDP is a connection-less protocol, so data delivery is not guaranteed. You will need to configure the settings of **Destination IPs**. The Destination IP field supports input of IP range and up to eight Destination IPs are supported.

Operation: Main → [3]COM Port Setting → [1-16]Select Port → [1]Link Mode → [3]UDP

```
-----  
UDP <COM1>  
-----  
[0]EXIT  
[1]Local Port           : 4660  
[2]Destination IP 1    : 000.000.000.000 ~ 000  
[3]Destination Port 1  : 4660  
[4]Destination 2      : Disable  
[5]Destination 3      : Disable  
[6]Destination 4      : Disable  
[7]Destination 5      : Disable  
[8]Destination 6      : Disable  
[9]Destination 7      : Disable  
[a]Destination 8      : Disable  
:  
:
```

Figure 48

3.10.4 Serial Settings

Here you can configure UART mode, baud rate, parity, data bit, stop bit, and flow control.

Operation: Main → [3]COM Port Setting → [1-16]Select Port → [2]Com Settings

```
-----  
COM1 Setting  
-----  
[0]EXIT  
[1]Uart mode      : RS232  
[2]Baud rate     : 9600 bps  
[3]Parity        : None  
[4]Data bits     : 8 bits  
[5]Stop bits     : 1 bit  
[6]Flow control  : None -> Xon/Xoff  
:  
_
```

Figure 49

3.11 Alert Settings

There are two sub-menu settings included inside the Alert Settings, which are E-mail Settings and Alert Event.

```
-----  
Alert Settings  
-----  
[0]EXIT  
[1]E-mail Settings  
[2]Alert Event  
:  
_
```

Figure 50

3.11.1 Configuring E-mail

When an alert event triggered, SC10E08A/ SC10E16A1 Series can send that event through email. Here you can configure **Sender's Email Address**, **Receiver's Email Address** (up to 5), **Mail Server**, and **Require Authentication**.

Operation: Main → [4]Alert Settings → [1]E-mail Settings

```
-----  
E-mail Setting  
-----  
[0]EXIT  
[1]Sender's Email Address      :  
[2]Receiver's Email Address 1  :  
[3]Receiver's Email Address 2  :  
[4]Receiver's Email Address 3  :  
[5]Receiver's Email Address 4  :  
[6]Receiver's Email Address 5  :  
[7]Mail Server                 :  
[8]Require Authentication      : No  
:
```

Figure 51

3.11.2 Configuring Alert Event

Choose the Alert events that SC10E08A/ SC10E16A1 Series should trigger and the method it should use to notify that event (Email, Trap, or Relay). Available events are **Cold Start, Warm Start, Authentication Failure, IP Address Change, Password Change, and Link Down.**

Operation: Main → [4]Alert Settings → [2]Alert Event

```
-----  
Alert Event  
-----  
[0]EXIT  
[1]Cold Start                  : Email ON, Trap ON  
[2]Warm Start                  : Email ON, Trap ON  
[3]Authentication Failure      : Email ON, Trap ON  
[4]IP Address Changed          : Email ON  
[5]Password Changed           : Email ON  
[6]LAN1 Link Down              : Relay ON  
[7]LAN2 Link Down              : Relay ON  
:
```

Figure 52

3.12 System Configuration

There are three sub-menus included inside the System Settings, which are Link State, Time, and Security.

Operation: Main → [5]System

```

-----
                System Settings
-----
[0]EXIT
[1]Link State
[2]Time           : Manual
[3]Security
:
    
```

Figure 53

3.12.1 Link State

Link State information of each COM port will be displayed.

Operation: Main → [5]System → [1]Link State

```

Remark: L-Listen, C-Connecting, D-Connected, R-Ready
-----
Port  Type      IP1    IP2    IP3    IP4    IP5    IP6
-----
01 TCP Server  L
02 TCP Client C
03 UDP        R
04 TCP Server L
05 TCP Server L
06 TCP Server L
07 TCP Server L
08 TCP Server L
09 TCP Server L
10 TCP Server L
11 TCP Server L
12 TCP Server L
13 TCP Server L
14 TCP Server L
15 TCP Server L
16 TCP Server L

Press '0' to cancel ...
    
```

Figure 54

3.12.2 Time Settings

You can configure the system time manually or let SC10E08A/ SC10E16A1 Series retrieve time information from a NTP server. The changed will take effect immediately after the settings are saved.

Operation: Main → [5]System → [2]Time

```
-----  
Time Settings  
-----  
[0]EXIT  
[1]Manual      : 2013-03-04 09:40:35  
[2]NTP        : Disable  
:  
_
```

Figure 55

3.12.3 Security Settings

You can change the system password here. Moreover, you can block different access method to prevent system intrusion.

Operation: Main → [5]System → [3]Security

```
-----  
Security  
-----  
[0]EXIT  
[1]Change Password  
[2]Web Console      : Enable  
[3]Telnet Console   : Enable  
[4]LCM Password Protect : Disable  
[5]Reset Button Protect : Disable  
:  
_
```

Figure 56

Note: Please be aware not to disable options [2-3] all together because further configuration would be not possible.

3.13 Restoring Factory Default

Choose and confirm this option to reset SC10E08A/ SC10E16A1 Series back to its default settings. The device would restart automatically to apply the default settings.

Operation: Main → [8]Set to Default



Figure 57

3.14 Restart System

Choose and confirm this option to restart SC10E08A/ SC10E16A1 Series.

Operation: main → [9]Restart

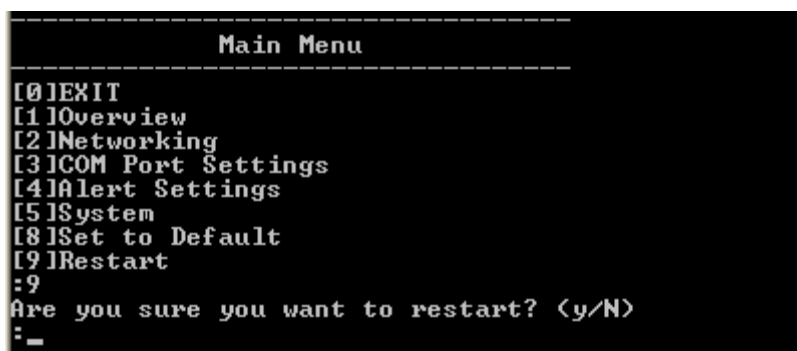

Figure 58

4 Link Modes and Applications

4.1 Link Mode Configuration

SC10E08A/ SC10E16A1 Series supports different Link Modes, which are TCP Server, TCP Client, and UDP. Under the three Link Modes, TCP Server can support RAW, Virtual COM, or Reverse Telnet applications. TCP Client can support Virtual COM application. In the upcoming sections, we will discuss how to setup different Link Modes properly.

Modes		Supports
TCP	Server	<ul style="list-style-type: none"> ■ RAW ■ VCOM

	<ul style="list-style-type: none"> ■ Reverse Telnet
Client	<ul style="list-style-type: none"> ■ VCOM
UDP	Connectionless protocol

4.1.1 TCP Server Mode

SC10E08A/ SC10E16A1 Series can be configured as a TCP server in a TCP/IP Network to listen for an incoming TCP client connection to a serial device. After the connection is established between the serial device server and the host computer, data can be transmitted in both directions; this also applies whenever the VCOM is running on server mode. Please be reminded that this is the device's default link mode.

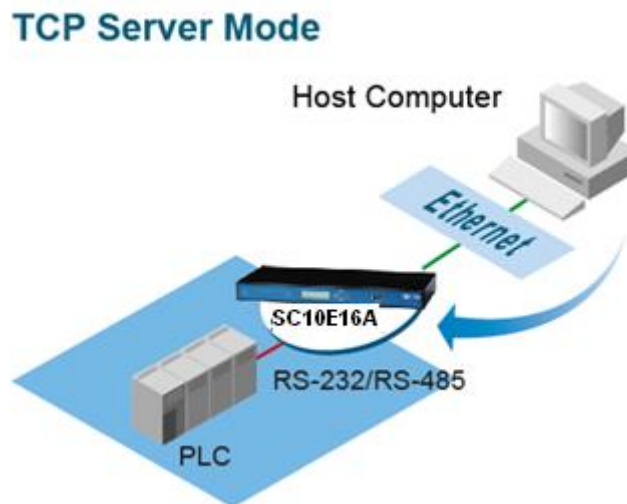

Figure 59

SC10E08A/ SC10E16A1 Series defaults in TCP Server mode, there are additional connection settings that can be configured. By selecting the TCP Server mode, a TCP Client program should be prepared to connect to SC10E08A/ SC10E16A1 Series.

<input checked="" type="radio"/> TCP Server <input type="radio"/> TCP Client <input type="radio"/> UDP	
TCP Server	
Mode	RAW
Max. Connections	1
	<input type="radio"/> Request & Response Mode <input type="radio"/> Reply to requester only <input checked="" type="radio"/> Reply to all <input checked="" type="radio"/> Transparent Mode
IP Filter	<input type="checkbox"/> Enable
Source IP	0 . 0 . 0 . 0
Local Port	4660
<input type="checkbox"/> Apply to all serial ports (Local Port will be enumerated automatically.)	

Figure 60

For setting as a TCP Server, please follow these steps.

- Click on the COMX link under **Serial** on the left hand side.
- Select TCP Server in the Link Modes; TCP Server is the default link mode. Also in this section you will find the following options.
 - ◆ **Mode**, there are 3 different communication modes here:
 - **RAW**, there is no protocol on this mode, meaning the data is passed transparently.
 - **Virtual COM**, the Virtual COM protocol is enabled on the device to communicate with a virtualized port from the client. It is possible to create a Virtual COM port on Windows/Linux in order to communicate with the device as a Client.
 - **Reverse Telnet**, used to connect the device and another serial device (usually a Terminal Server) with a Telnet program. Telnet programs in Windows / Linux usually require special handshaking to get the outputs and formatting show properly. The SC10E08A/ SC10E16A1 Series will interact with those special commands (CR/LF commands) once Reverse Telnet is enabled.
- Enter the Local Port, this option specifies the port number that the server should listen to; it is used by the client to connect to the server. Default local port is 4660.
- Go to **Response Behavior** for more information on this setting. For serial settings, go to **Sec.3.4.1**. For Advanced settings, go to **Sec.3.4.2**.

-
- Scroll to the bottom of the page and click on “**Save Configuration**” button to save the changes.

Other important variables to consider are:

- **IP Filter**, enables the Source IP option below to block an IP address from accessing the COM port.
- **Source IP**, specifies the device’s Source IP which will be transmitting data to our Server. In other words, our Server will only allow data from this IP to flow (hence its own name implies Source IP); only one source is allowed.
- **Maximum Connection**, the number of devices/clients (max. of 4 clients), to be served is set in this section.
- **Response Behavior**, in which we will have as options:
 - ◆ **Request & Response Mode**, it determines how the device will proceed when it receives requests from connected hosts. Under this mode, the port will hold requests from all other connected hosts until the serial device replies or the Response Interval timeout takes into effect to discard it; however, unrequested data sent from the serial device would be forwarded to all connected hosts.
 - **Reply to requester only**, the port will reply to the connected host who requested the data only.
 - **Reply to all**, a reply is sent to all connected hosts.
 - ◆ **Transparent mode**, the port will forward requests from all connected hosts to the serial device immediately and reply to all connected hosts once it receives data from the serial device.

Note: LINK1 is associated with COM1; LINK2 is associated with COM2, and so on.

4.1.2 TCP Client Mode

SC10E08A/ SC10E16A1 Series can be configured as a TCP client in TCP/IP Network to establish a connection with a TCP server in the host computer. After the connection is established, data can be transmitted between a serial device and a host computer in both directions; this also applies to Virtual COM running in the client mode.

TCP Client Mode

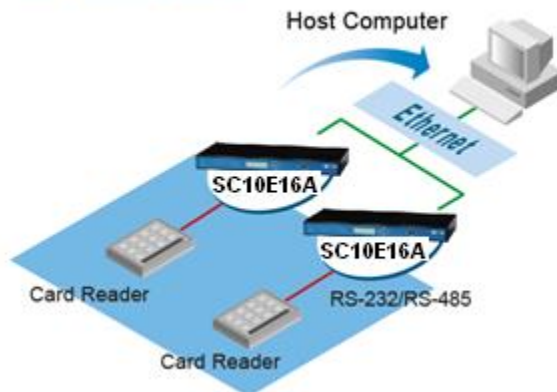

Figure 61

By selecting the TCP Client mode, it means that a TCP Server program should be prepared to connect to SC10E08A/ SC10E16A1 Series; Figure shows all the settings provided for the TCP Client.

<input type="radio"/> TCP Server <input checked="" type="radio"/> TCP Client <input type="radio"/> UDP	
TCP Client	
Mode	RAW
Destination IP 1	0 . 0 . 0 . 0
Destination Port 1	4660
Destination 2	<input type="checkbox"/> Enable
Destination IP 2	0 . 0 . 0 . 0
Destination Port 2	4660
	<input type="radio"/> Request & Response Mode <input type="radio"/> Reply to requester only <input checked="" type="radio"/> Reply to all <input checked="" type="radio"/> Transparent Mode
<input type="checkbox"/> Apply to all serial ports	

Figure 62

For setting as a TCP Client, please follow these steps.

- Click on the COMX port under **Serial** on the left hand side.
- Select TCP Client in the Link modes.
- Only two communication modes are available here: RAW and Virtual COM which definitions are the same as above in **Mode**.

- Enter the preferred **Destination IP** and **Port**. This should match the IP settings of the TCP Server program.
- Enable and enter Destination IP 2 and Port 2 if necessary. Two different servers can be set here (for redundancy), the second server has to be enabled by ticking the box.
- Go to **Response Behavior** for more information on this setting. For serial settings, go to **Sec.3.4.1**. For Advanced settings, go to **Sec.3.4.2**.
- Scroll to the bottom and click on **“Save Configuration”** button to save the changes.

4.1.3 UDP Mode

UDP is a faster but connectionless network protocol; it does not guarantee the delivery of network datagram. The SC10E08A/ SC10E16A1 Series can be configured to transfer data using unicast or multicast UDP from the serial device to one or multiple host computers, data can be transmitted between serial device and host computer in both directions.

There is no **server** or **client** concept on this protocol, they are called **peers** or **nodes**. So here you only need to specify the **Local Port** that we should listen to and specify the **Destination IPs** of the remote **UDP nodes**.

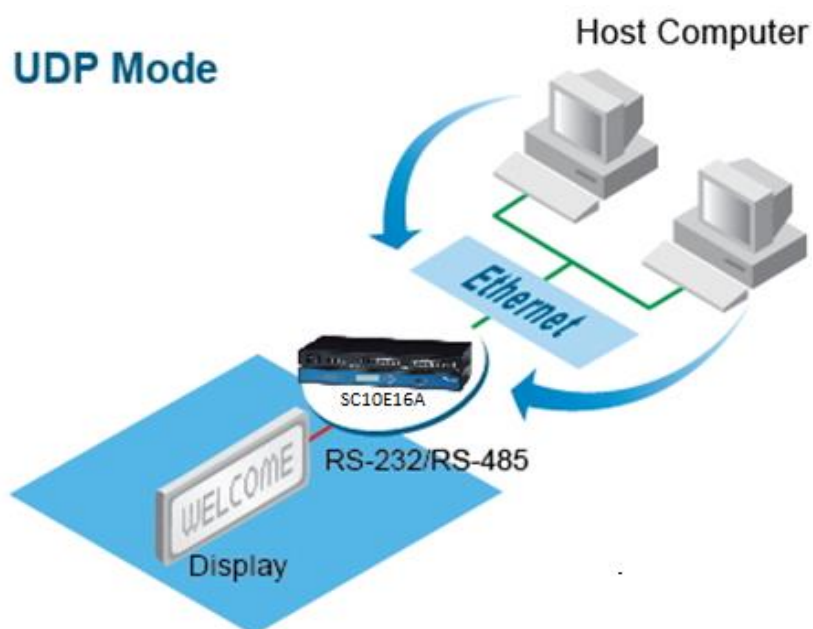
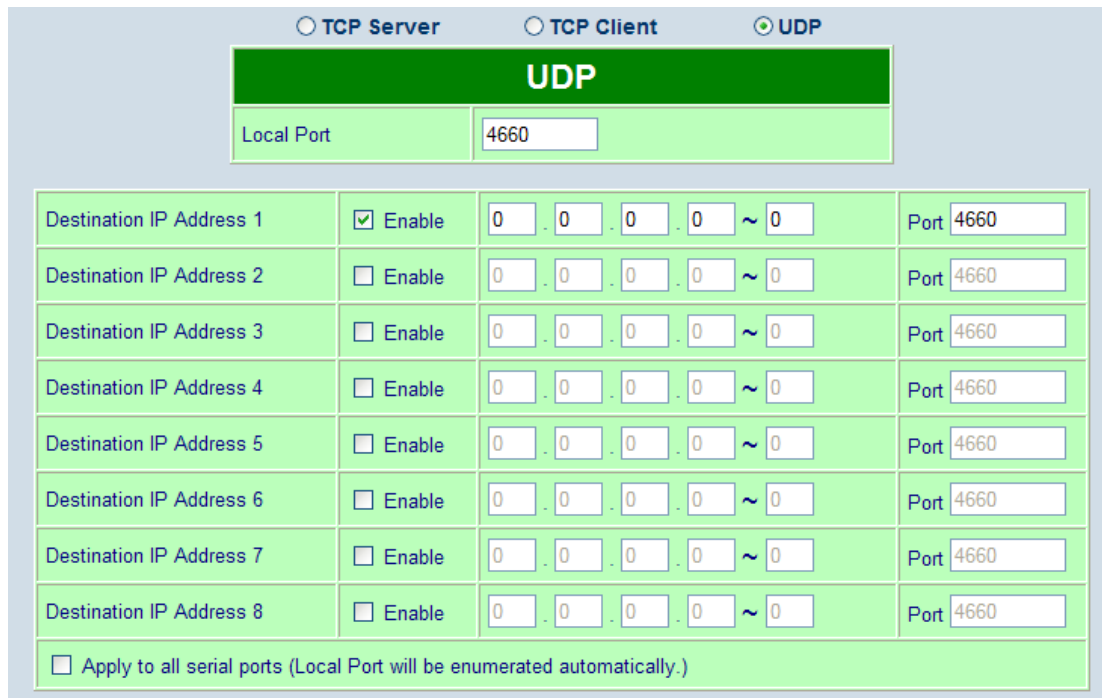

Figure 63

SC10E08A/ SC10E16A1 Series also supports connectionless UDP protocol compared to the connection-oriented TCP protocol. Please be aware that even though UDP provides better efficiency in terms of response time and resource usage, it does not guarantee data delivery. It is recommended

to utilize UDP only with cyclic polling protocols where each request is repeated and independent, such as Modbus Protocol; Figure shows the UDP settings.



UDP				
Local Port		4660		
Destination IP Address 1	<input checked="" type="checkbox"/> Enable	0 . 0 . 0 . 0 ~ 0	Port 4660	
Destination IP Address 2	<input type="checkbox"/> Enable	0 . 0 . 0 . 0 ~ 0	Port 4660	
Destination IP Address 3	<input type="checkbox"/> Enable	0 . 0 . 0 . 0 ~ 0	Port 4660	
Destination IP Address 4	<input type="checkbox"/> Enable	0 . 0 . 0 . 0 ~ 0	Port 4660	
Destination IP Address 5	<input type="checkbox"/> Enable	0 . 0 . 0 . 0 ~ 0	Port 4660	
Destination IP Address 6	<input type="checkbox"/> Enable	0 . 0 . 0 . 0 ~ 0	Port 4660	
Destination IP Address 7	<input type="checkbox"/> Enable	0 . 0 . 0 . 0 ~ 0	Port 4660	
Destination IP Address 8	<input type="checkbox"/> Enable	0 . 0 . 0 . 0 ~ 0	Port 4660	
<input type="checkbox"/> Apply to all serial ports (Local Port will be enumerated automatically.)				

Figure 64

- Click on the COMX port under **Serial** on the left hand side.
- Select UDP in the Link modes.
- **Destination IP and Port:** Specify the **Begin** and **End IP** here. Four groups of range IPs are allowed. This is the **IP** address of the UDP program and the **Port** it is listening to. Note that the maximum number of UDP nodes that SC10E08A/ SC10E16A1 Series can handle would highly depend on the traffic load. *We have tested that SC10E08A/ SC10E16A1 Series can handle up to 100 UDP nodes (baud rate 9600 bps, request interval 100ms, and data length 30bytes).*
- Enter the **Local Listening Port**. This is the port that SC10E08A/ SC10E16A1 Series should listen to. Match this setting in the UDP program (usually called destination port in the UDP program).
- For serial settings, go to **Sec.3.4.1**. For Advanced settings, go to **Sec.3.4.2**.
- Scroll to the bottom of the page and click on “**Save Configuration**” button to save the changes.

4.2 Link Mode Applications

4.2.1 TCP Server Application: Enable Virtual COM

SC10E08A/ SC10E16A1 Series will encapsulate control packets on top of the real data when Virtual COM is enabled. This will allow the Virtual COM port in the Windows/Linux system to access SC10E08A/ SC10E16A1 Series' COM ports. The benefit of using Virtual COM is that rewriting an existing COM program to read IP packets is unnecessary. In other words, it is possible to use an ordinary serial (COM) program. The conversion/virtualization of IP to COM is all done in the system driver transparently. Figure shows SC10E08A/ SC10E16A1 Series in TCP Server mode with Virtual COM enabled.

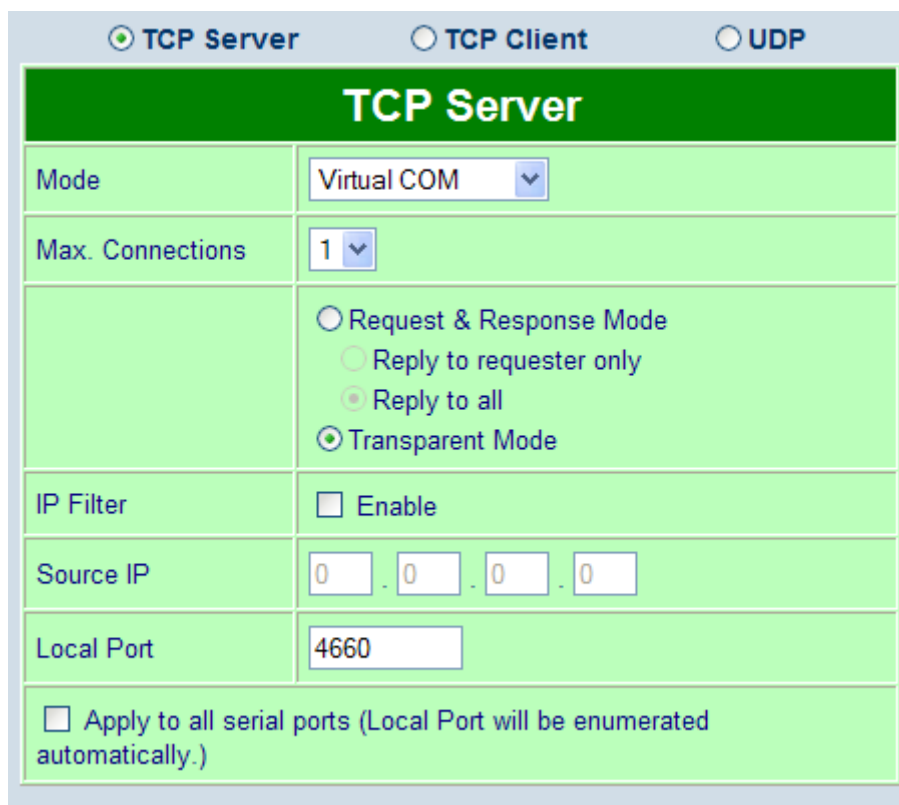

Figure 65

- Follow **Sec 4.1.1** to configure SC10E08A/ SC10E16A1 Series in TCP Server mode properly.
- Click on the dropdown box of the **Mode** option and switch to “**Virtual COM**” to enabled Virtual COM application in SC10E08A/ SC10E16A1 Series.
- Scroll to the bottom of the page and click on “**Save Configuration**” button to save the changes.
- Configure Virtual COM in the Operating System. For Windows, refer to **Chapter 5**. For Linux, refer to a separate manual included in the Linux driver zip file. Remember SC10E08A/

SC10E16A1 Series' IP address and **Local Port** here in order to enter this information in Serial/IP Virtual COM's Control Panel later.

4.2.2 TCP Server Application: Enable RFC 2217

The underlying protocol of Virtual COM is based on RFC 2217, the Telnet COM Control Option. Therefore, it is possible to use RFC 2217 with SC10E08A/ SC10E16A1 Series in the TCP Server mode. To do so, refer to **Sec 4.2.1** to enable Virtual COM, so that SC10E08A/ SC10E16A1 Series becomes aware of the commands. Note that there is no need to configure Virtual COM on the Operating System because Virtual COM ports would not be used.

4.2.3 TCP Client Application: Enable Virtual COM

It is also possible to run VCOM in TCP Client mode. It is usually easier to use Virtual COM in the Client mode if SC10E08A/ SC10E16A1 Series uses dynamic IP (DHCP) because setting a static IP address in Virtual COM's Control Panel in the Operating System is not possible.

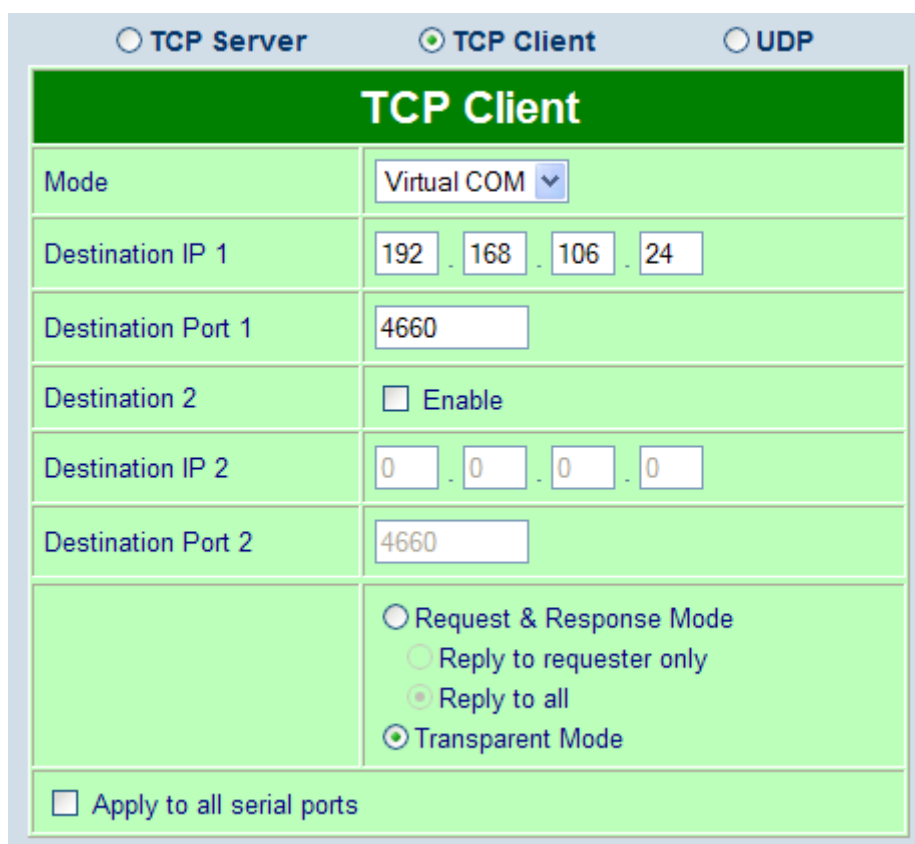

Figure 66

- Follow **Sec. 4.1.2** to configure SC10E08A/ SC10E16A1 Series in TCP Client mode properly.

- Click on the dropdown box of the **Mode** option and switch to “**Virtual COM**” to enabled Virtual COM application in SC10E08A/ SC10E16A1 Series.
- Scroll to the bottom of the page and click on “**Save Configuration**” button to save the changes.
- Configure Virtual COM in the Operating System. For Windows, refer to **Chapter 5**. For Linux, refer to a separate manual included in the Linux driver zip file. Remember the Destination Port here in order to enter this information in Serial/IP Virtual COM’s Control Panel later.

4.2.4 TCP Client Application: Enable RFC 2217

The underlying protocol of Virtual COM is based on RFC 2217, the Telnet COM Control Option. Therefore, it is possible to use RFC 2217 with SC10E08A/ SC10E16A1 Series in the TCP Client mode. To do so, refer to **Sec. 4.2.3** to enable Virtual COM, so that SC10E08A/ SC10E16A1 Series becomes aware of the commands. Note that there is no need to configure Virtual COM on the Operating System because Virtual COM ports would not be used.

4.2.5 TCP Server Application: Configure SC10E08A/ SC10E16A1 Series as a Pair Connection Master

Pair Connection is useful when pairing up two serial devices over the Ethernet or when it is impossible to install Virtual COM in the serial device. Pair connection does require two SC10E08A/ SC10E16A1 Series to work in pair, one would be the Pair Connection Master and the other would be the Pair Connection Slave.

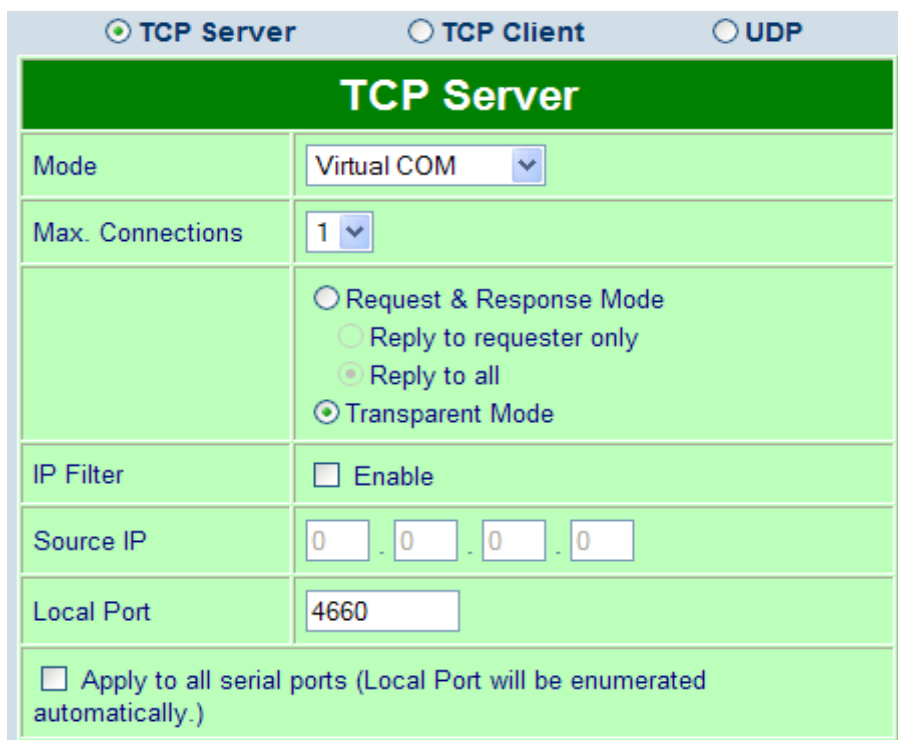

TCP Server	
Mode	Virtual COM
Max. Connections	1
	<input type="radio"/> Request & Response Mode <input type="radio"/> Reply to requester only <input checked="" type="radio"/> Reply to all <input checked="" type="radio"/> Transparent Mode
IP Filter	<input type="checkbox"/> Enable
Source IP	0 . 0 . 0 . 0
Local Port	4660
<input type="checkbox"/> Apply to all serial ports (Local Port will be enumerated automatically.)	

Figure 67

- Follow **Sec. 4.2.1** to configure SC10E08A/ SC10E16A1 Series in TCP Server mode properly.
- Click on the dropdown box of the **Mode** option and switch to “**Virtual COM**” to enabled Virtual COM application in SC10E08A/ SC10E16A1 Series.
- Scroll to the bottom of the page and click on “**Save Configuration**” button to save the changes.
- Remember Pair Connection Master’s IP address here in order to enter this information in the Slave later.
- Proceed to the **Sec. 4.2.6** to configure a Slave to connect to this Master.

4.2.6 TCP Client Application: Configure SC10E08A/ SC10E16A1 Series as a Pair Connection Slave

A **Pair Connection Slave**, is shown in Figure ; it is necessary to pair up with a **Pair Connection Master**. Please setup a **Pair Connection Master** first before proceeding.

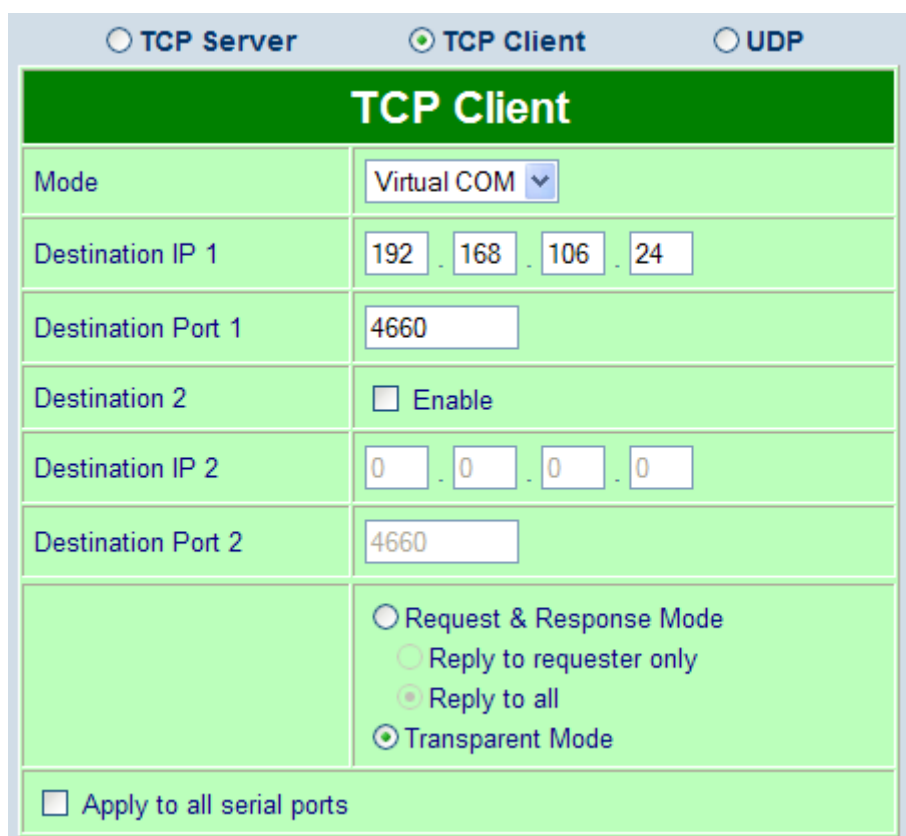

TCP Client	
Mode	Virtual COM
Destination IP 1	192 . 168 . 106 . 24
Destination Port 1	4660
Destination 2	<input type="checkbox"/> Enable
Destination IP 2	0 . 0 . 0 . 0
Destination Port 2	4660
<input type="radio"/> Request & Response Mode <input type="radio"/> Reply to requester only <input checked="" type="radio"/> Reply to all <input checked="" type="radio"/> Transparent Mode	
<input type="checkbox"/> Apply to all serial ports	

Figure 68

- Follow **Sec. 4.1.2** to configure SC10E08A/ SC10E16A1 Series in TCP Client mode properly.
- Click on the dropdown box of the **Mode** option and switch to “**Virtual COM**” to enabled Virtual

COM application in SC10E08A/ SC10E16A1 Series.

- Match the Destination IP with the settings of Pair Connection Master’s IP that was setup previously.
- Scroll to the bottom of the page and click on “**Save Configuration**” button to save the changes.

4.2.7 TCP Server Application: Enable Reverse Telnet

Reverse Telnet is useful if a telnet program is used to connect to SC10E08A/ SC10E16A1 Series and the serial interface of the SC10E08A/ SC10E16A1 Series is connected to a Terminal Server. Telnet programs in Windows/Linux require special handshaking to get the outputs and formatting show properly. SC10E08A/ SC10E16A1 Series will interact with those special commands (CR/LF commands) if Reverse Telnet is enabled.

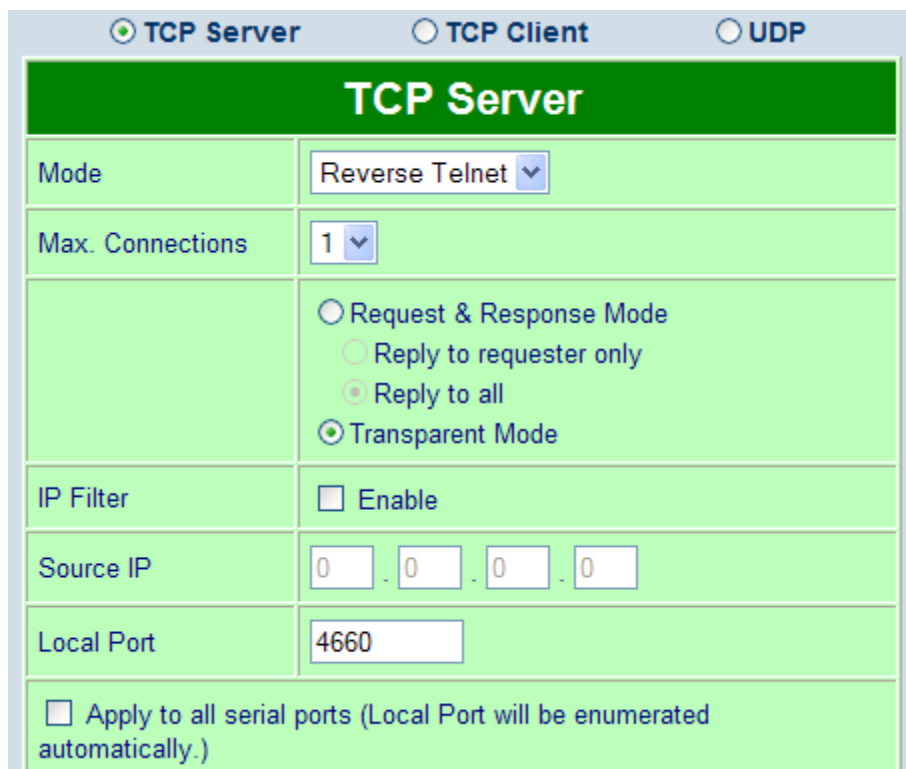

Figure 69

- Follow **Sec. 4.2.1** to configure SC10E08A/ SC10E16A1 Series in TCP Server mode properly.
- Click on the dropdown box of the **Mode** option and switch to “**Reverse Telnet**” to enabled Reverse Telnet application in SC10E08A/ SC10E16A1 Series.
- Scroll to the bottom of the page and click on “**Save Configuration**” button to save the changes.

4.2.8 UDP Application: Multi-Point Pair Connection

It is also possible to setup pair connection in UDP mode to have more than one Pair Connection Master or Slave to communicate to each other. For example, it is possible to setup one Modbus Master and six Modbus Slaves in UDP, Figure . Note again that UDP does not guarantee data delivery and only data would be transmitted over Ethernet; other serial pings are not transmitted. If RS-232 along with flow control, it is recommended to use Multi-Point Pair Connection in TCP, see **Sec. 4.2.10**.

Note: the destination IP and Port of the Slaves need to be equal to the Master's IP and Port. Local Listening Port for the Slaves need to be equal to the Master's Destination Port, see table below for an example.

	IP Address	Link Mode	Local Listening Port	Destination IP	Destination Port
SC10E08A/ SC10E16A1 Series Master COM1	10.0.50.100	UDP	5000	10.0.50.200~10.0.50.202	5000
SC10E08A/ SC10E16A1 Series Master COM1	10.0.50.100	UDP	5001	10.0.50.200~10.0.50.201	5000
SC10E08A/ SC10E16A1 Series Master COM1	10.0.50.100	UDP	5002	10.0.50.200	5000
SC10E08A/ SC10E16A1 Series Slave 1 COM1	10.0.50.200	UDP	5000	10.0.50.100	5000
SC10E08A/ SC10E16A1 Series Slave 1 COM2	10.0.50.200	UDP	5001	10.0.50.100	5001
SC10E08A/ SC10E16A1 Series Slave 1 COM3	10.0.50.200	UDP	5002	10.0.50.100	5002
SC10E08A/ SC10E16A1 Series Slave 2 COM1	10.0.50.201	UDP	5000	10.0.50.100	5000
SC10E08A/ SC10E16A1 Series Slave 2 COM2	10.0.50.201	UDP	5001	10.0.50.100	5001
SC10E08A/ SC10E16A1	10.0.50.202	UDP	5000	10.0.50.100	5000

Series Slave 3 COM1					
---------------------	--	--	--	--	--

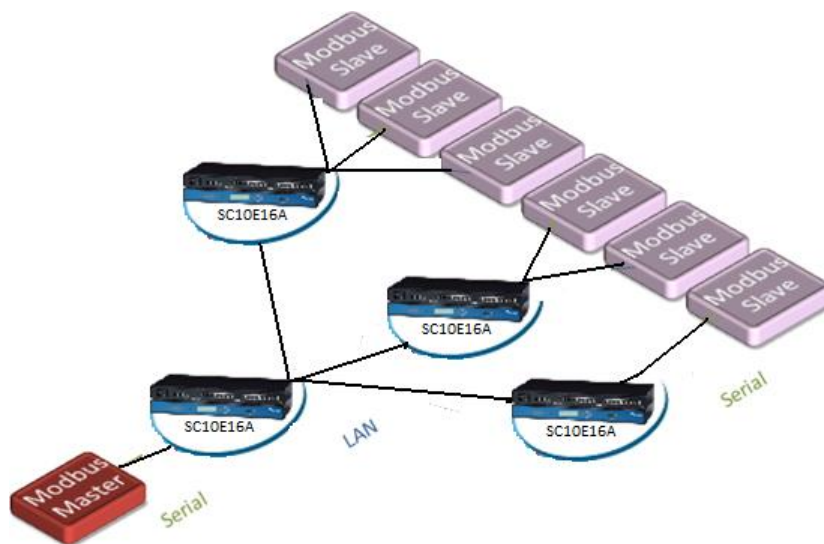

Figure 70

4.2.9 TCP Server Application: Multiple TCP Connections

The Multi-Connection option will allow up to a maximum of four TCP Client connections. Note that it is also possible to use this multi-connection feature in conjunction with other TCP Server applications, such as Virtual COM, Pair Connection, and Reverse Telnet. For example, enabling multi-connection along with Pair Connection will result in Multi-Point Pair Connection in TCP mode (**Sec. 4.2.10**). For more information on Response behaviors please go to (**Response Behavior**).

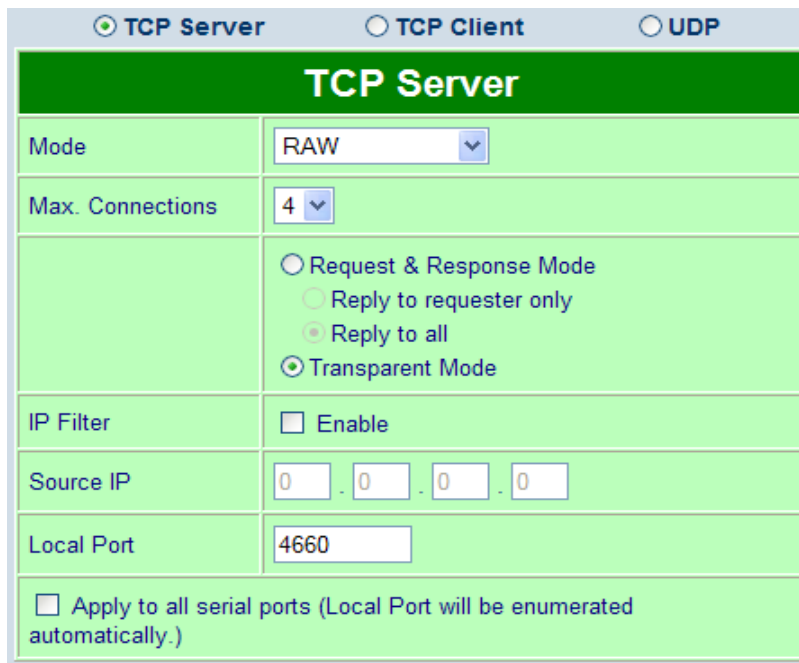

Figure 71

4.2.10 TCP Server Application: Multi-Point TCP Pair Connections

The difference between Multi-Point TCP Pair Connection and Multi-Point UDP Pair Connection is that the TCP implementation would also exchange flow control pins for RS-232. However, the TCP Server is limited to a maximum of four connections. If there are four serial devices and they don't use flow control pins with RS-232 or RS-485, it is possible to setup pair connection in UDP mode, **Sec. 4.2.8**. After multi-connection is enabled in the WebUI, refer to the following table to setup Pair Connection as in Figure.

	IP Address	Link Mode	Application	Local Listening Port	Destination IP	Destination Port
SC10E08A/ SC10E16A1 Series Master COM1	10.0.50.100	TCP Server	Pair Connection Master	4660	-	-
SC10E08A/ SC10E16A1 Series Slave 1 COM1	10.0.50.200	TCP Client	Pair Connection Slave	-	10.0.50.100	4660
SC10E08A/ SC10E16A1 Series Slave 1 COM2	10.0.50.200	TCP Client	Pair Connection Slave	-	10.0.50.100	4660
SC10E08A/ SC10E16A1 Series Slave 2 COM3	10.0.50.200	TCP Client	Pair Connection Slave	-	10.0.50.100	4660
SC10E08A/ SC10E16A1	10.0.50.201	TCP Client	Pair Connection Slave	-	10.0.50.100	4660

Series Slave 3 COM1						
---------------------	--	--	--	--	--	--

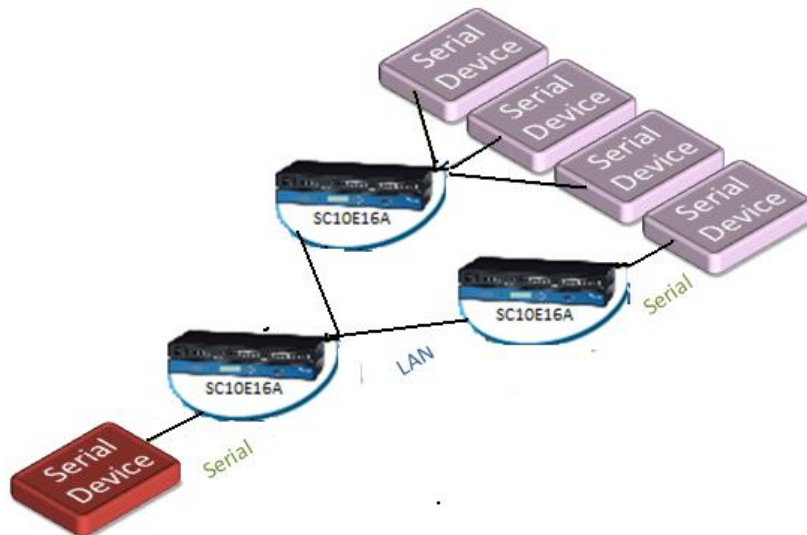

Figure72

5 VCOM Installation & Troubleshooting

5.1 Enabling VCOM

SC10E08A/ SC10E16A1 Series will encapsulate control packets on top of the real data when Virtual COM is enabled. This will allow the Virtual COM port in the Windows/Linux system to access SC10E08A/ SC10E16A1 Series' COM ports. Remember that VCOM can only be enabled on TCP Server Mode or TCP Client, Figure .

TCP Server
 TCP Client
 UDP

TCP Server

Mode	RAW (Dropdown menu open showing: RAW, Virtual COM, Reverse Telnet)
Max. Connections	(Dropdown menu open showing: RAW, Virtual COM, Reverse Telnet)
	<input type="radio"/> Request & Response Mode <input type="radio"/> Reply to requester only <input checked="" type="radio"/> Reply to all <input checked="" type="radio"/> Transparent Mode
IP Filter	<input type="checkbox"/> Enable
Source IP	0 . 0 . 0 . 0
Local Port	4660
<input type="checkbox"/> Apply to all serial ports (Local Port will be enumerated automatically.)	

Figure 73

TCP Server
 TCP Client
 UDP

TCP Client

Mode	Virtual COM (Dropdown menu open showing: RAW, Virtual COM)
Destination IP 1	Virtual COM 06 . 24
Destination Port 1	4660
Destination 2	<input type="checkbox"/> Enable
Destination IP 2	0 . 0 . 0 . 0
Destination Port 2	4660
	<input type="radio"/> Request & Response Mode <input type="radio"/> Reply to requester only <input checked="" type="radio"/> Reply to all <input checked="" type="radio"/> Transparent Mode
<input type="checkbox"/> Apply to all serial ports	

Figure 74

Virtual COM allows remote access of serial devices over TCP/IP networks through Serial/IP Virtual COM ports that work like local native COM ports; Figure is a Virtual COM connection diagram.

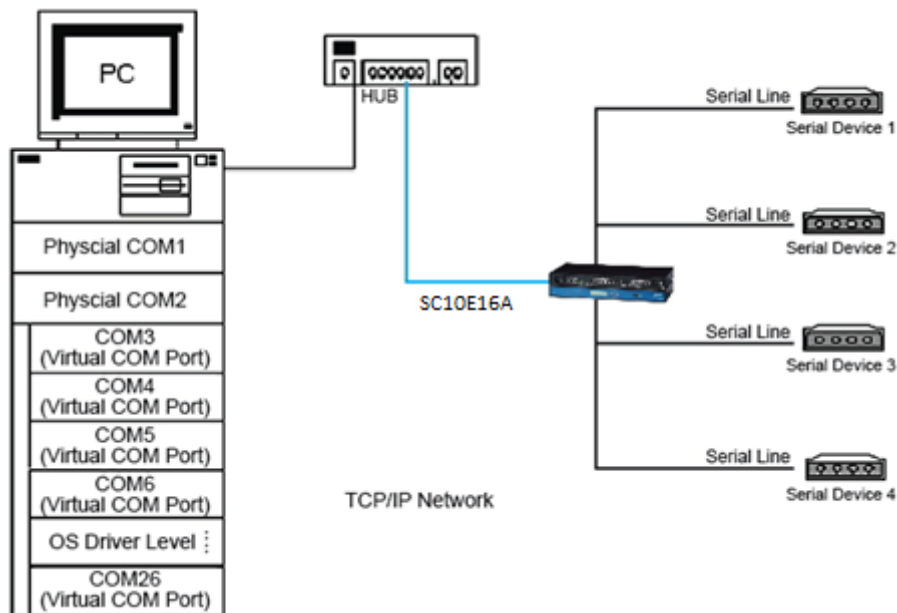

Figure 75

5.1.1 VCOM driver setup

System Requirements

- Windows 7/2008/Vista/2003/XP/2000/NT4/9x (32-bit or 64-bit version automatically installs)
- Native and virtual platforms, including Virtual Server and VMware
- Linux, also available but first you might need to download a separate package called Virtual COM driver for Linux (**TTYredirector**) available for download in the product CD. The zipped package includes a binary file for installation and a manual for Linux systems.

5.1.2 Limitations

The Virtual COM driver allows up to 256 **Virtual COM ports** in a single PC. Selecting in the range from COM1 to COM4096 is allowed. Note that COM ports already occupied by the system or other devices will not be available.

5.1.3 Installation

Run the Virtual COM setup file included in the CD or download a copy from our website to install the Virtual COM driver for the operating system. Turn off your anti-virus software and try again if installation fails. At the end of the installation, please select at least one Virtual COM port from the Serial/IP Control Panel.

5.1.4 Uninstalling

- From Windows Start Menu select Control Panel, Add/Remove Programs.
- Select Serial/IP Version x.x.x in the list of installed software.
- Click the Remove button to remove the program.

5.2 Enabling Virtual COM

5.2.1 Enable VCOM in Serial device servers

Enable Virtual COM in our serial device servers by logging into our WebUI. It is located under **COM configuration**. Figure show how to enable Virtual COM in SC10E08A/ SC10E16A1 Series. For a detailed **Link Mode configuration with Virtual COM**, please refer to **Sec. 4.2.1**.

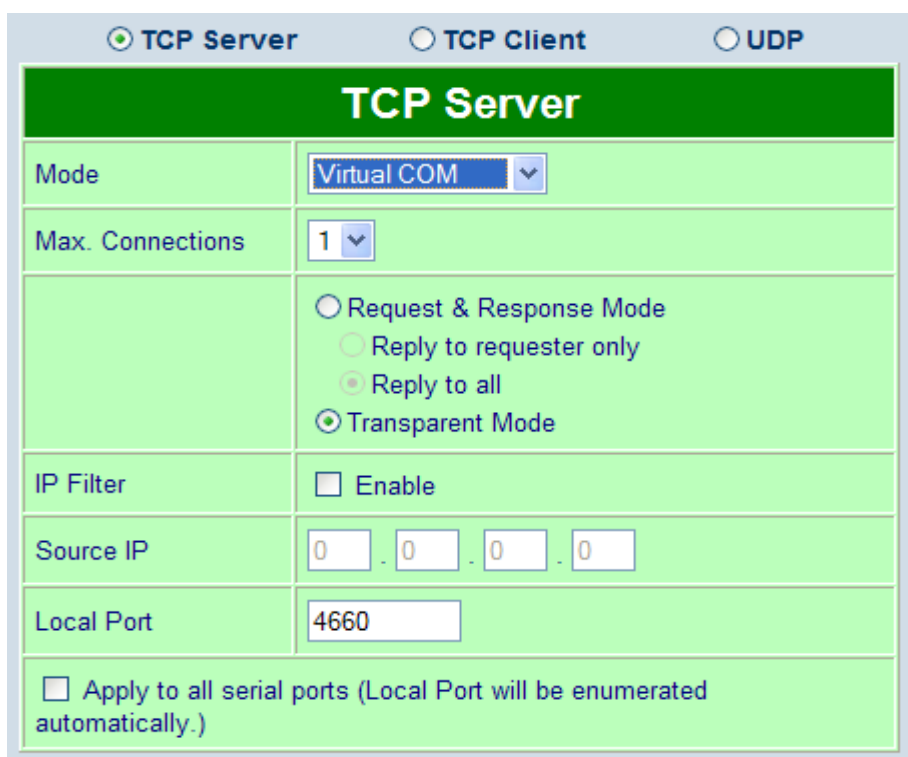

TCP Server	
Mode	Virtual COM
Max. Connections	1
	<input type="radio"/> Request & Response Mode <input type="radio"/> Reply to requester only <input checked="" type="radio"/> Reply to all <input checked="" type="radio"/> Transparent Mode
IP Filter	<input type="checkbox"/> Enable
Source IP	0 . 0 . 0 . 0
Local Port	4660
<input type="checkbox"/> Apply to all serial ports (Local Port will be enumerated automatically.)	

Figure 76

5.2.2 Running Serial/IP in Windows

Find Serial/IP Control Panel from:

- Start→ All Programs→ Serial/IP→ Control Panel
- In the Windows Control Panel, open the Serial/IP applet.
- In the Windows notification area, Figure ; right click in the Serial/IP tray icon and click on **Configure** to open the Control Panel.



Figure 77

If no Virtual COM port is selected, a dialog will pop up and asks to select at least one port as the Virtual COM port before proceeding, Figure .

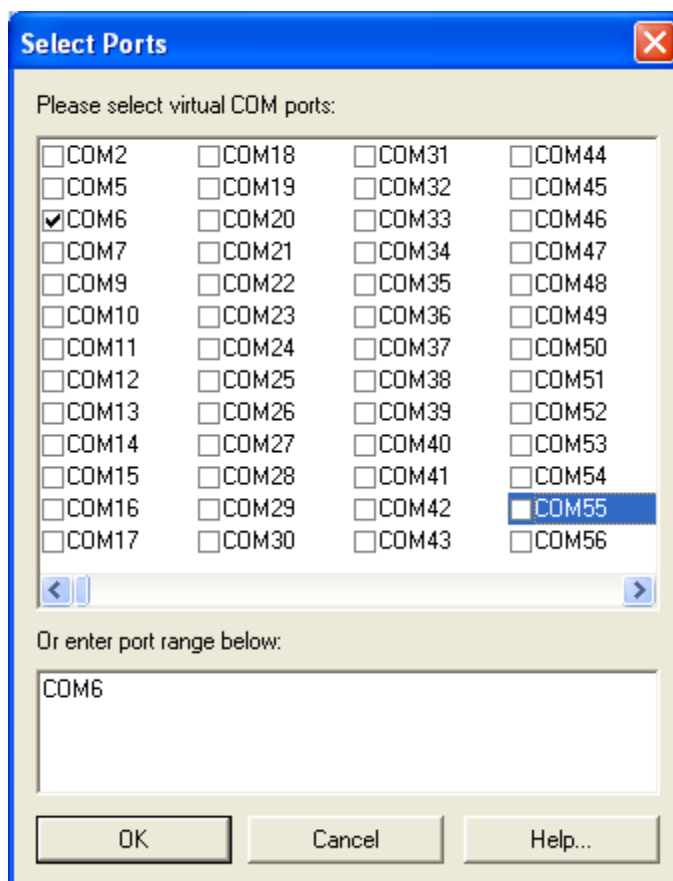

Figure 78

After at least one Virtual COM port is selected, the Control Panel will show, Figure .

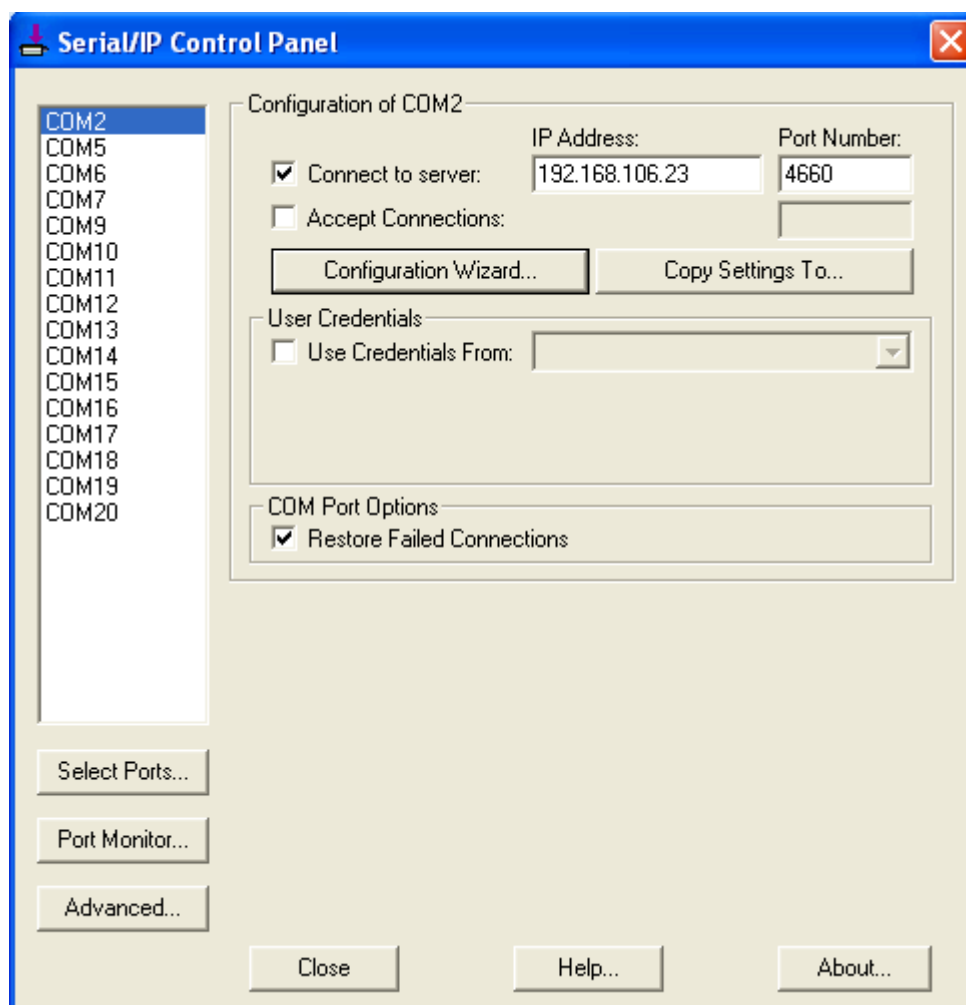

Figure 79

The left hand side of the Control Panel shows the list of selected Virtual COM ports. Click on **Select Ports** to add or remove Virtual COM ports from the list. The right hand side of the Control Panel shows the configurations of the selected Virtual COM port marked in blue. Each Virtual COM port can have its own settings.

Note: The changes to Virtual COM ports apply immediately, so there is no need to save the settings manually. However, if the Virtual COM port is already in use, it is necessary to close the Virtual COM port and open it after the TCP connection closes completely in order for the changes to take effect.

5.2.3 Configuring VCOM Ports

- If the serial device server is running in TCP Server mode (recommended), a Serial/IP should be the TCP Client connecting to the serial device server. Enable **Connect to Server** and enter the **IP Address** of the serial device server with the **Port Number** specified. The **Port Number** here is the Local Listening Port for the serial device server.
- If the serial device server is running in TCP Client mode, Serial/IP should be the TCP Server waiting for a serial device server to connect it. Enable **Accept Connections** and enter the **Port Number**. The **Port Number** here is the Destination Port of the serial device server. Do not enable **Connect to Server** and **Accept Connections** together.

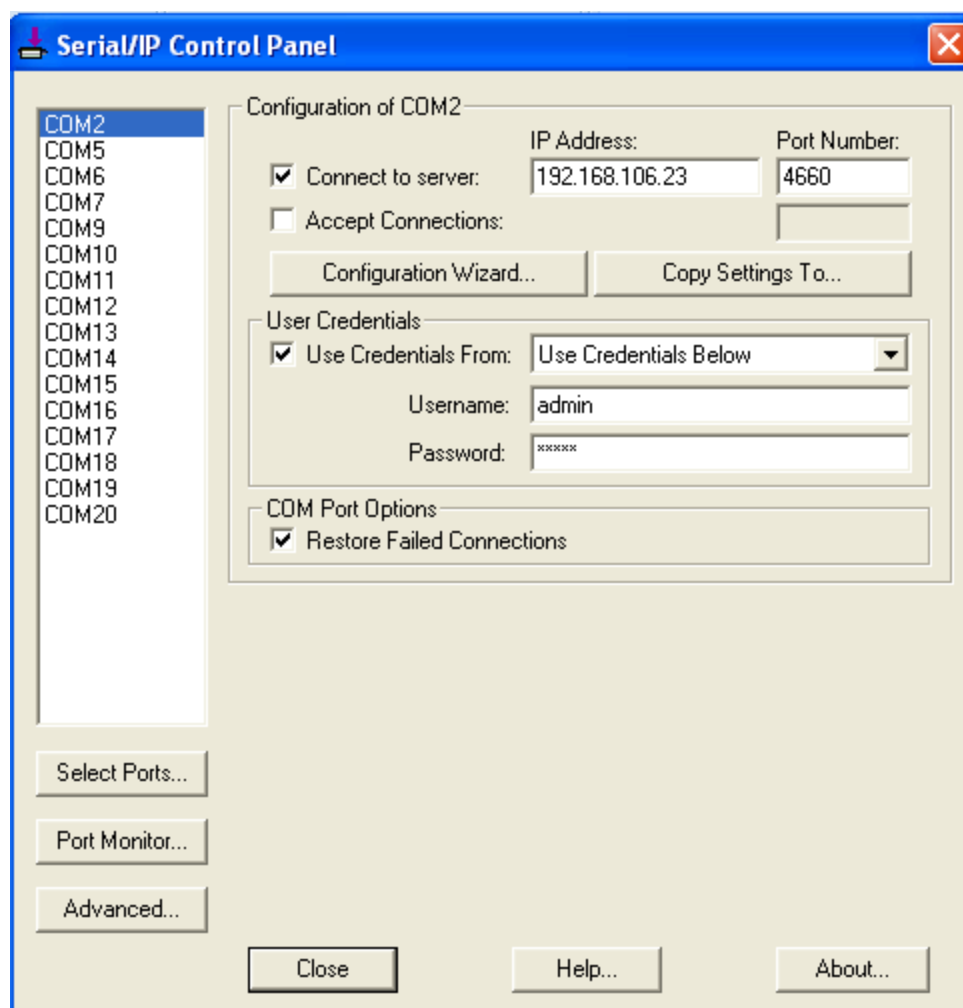

Figure 80

- Enable **Restore Failed Connections** to force Virtual COM to automatically restore failed

connections with the serial device server in the case of unstable network connections.

- To test the Virtual COM connection, click the Configuration Wizard button and then click **Start** button in the pop up window, Figure . If the test passes, all checks should be in green. To apply the changes in the Configuration Wizard window to the Control Panel, click on **Use Settings**. Click on **Copy** to copy the results to the system clipboard.
- To transfer the settings between Virtual COM ports, click on the Copy Settings To button.

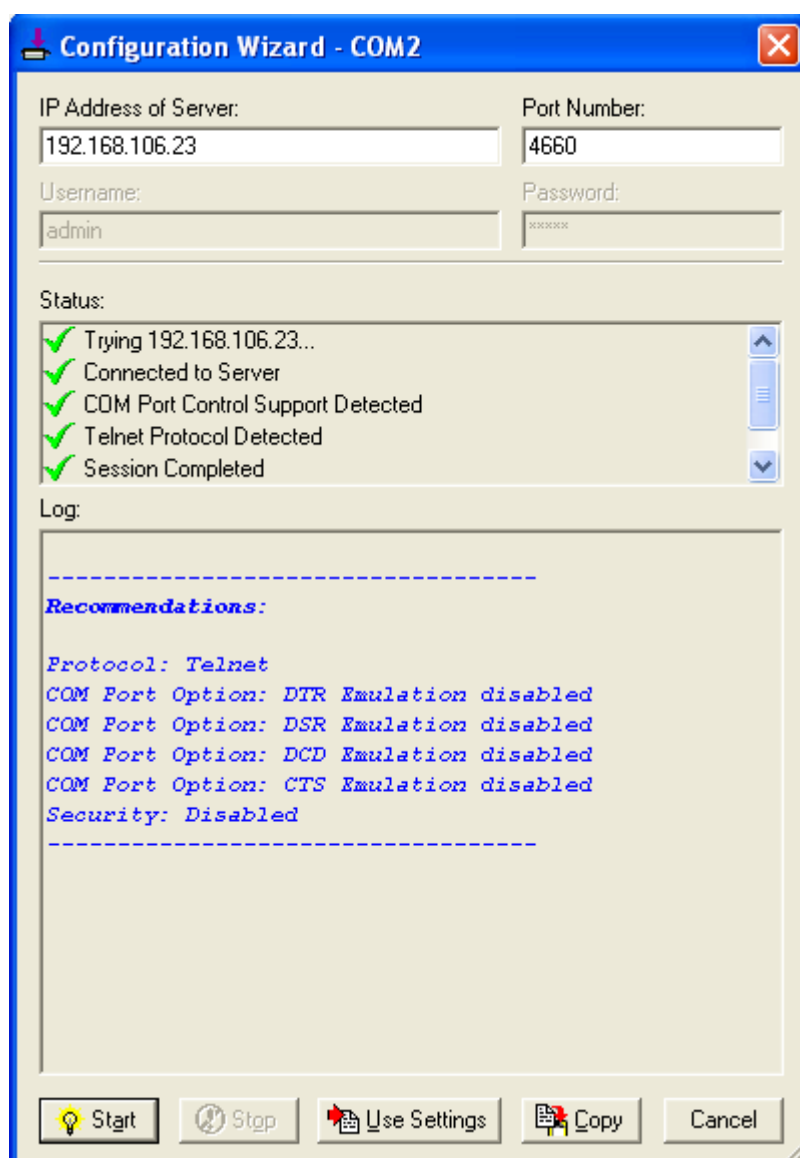

Figure 81

5.2.4 Exceptions

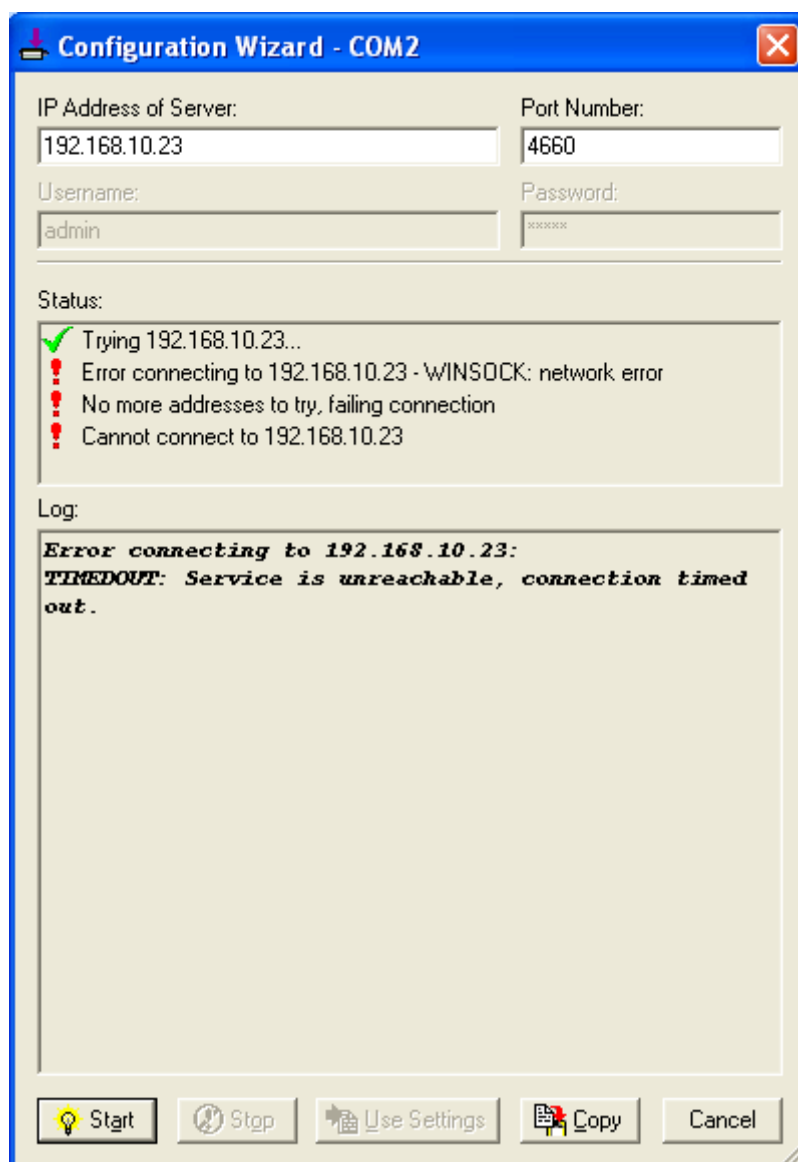

Figure 82

If the exclamation mark begins with **Warning: timeout trying x.x.x.x** as in Figure , recheck the **VCOM IP** and **Port configuration** or the PC's **network configuration**.

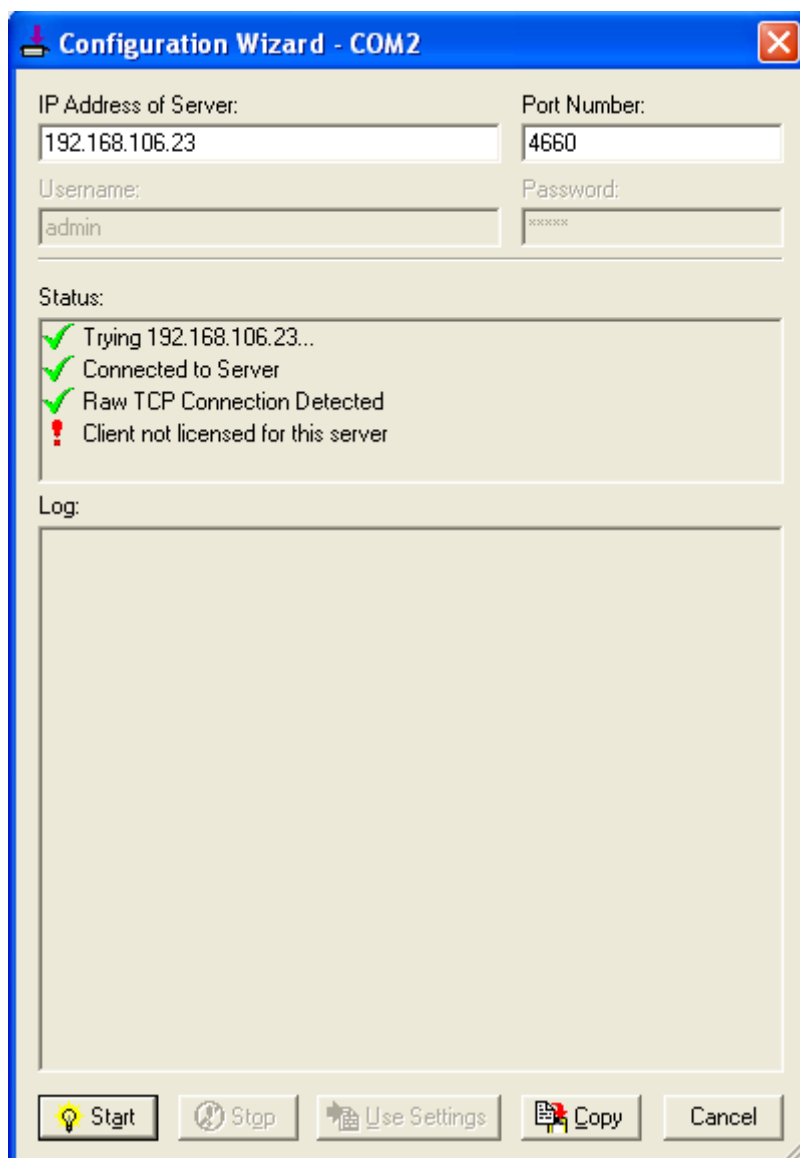

Figure 83

If there is a check with **Raw Connection Detected** and an exclamation mark with **Client not licensed for this server**, Figure , enable VCOM in the serial device server.

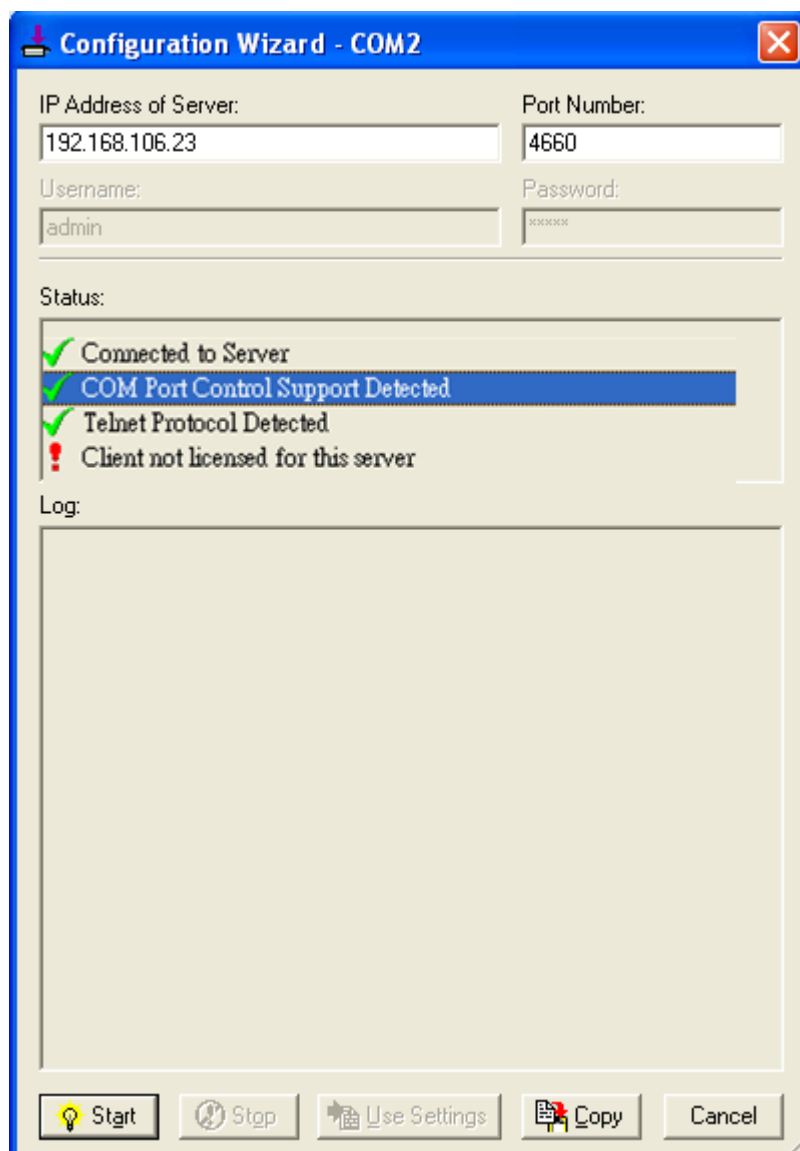

Figure 84

If there is a check with **Telnet Protocol Detected** and an exclamation mark with **Client not licensed for this server** as in Figure , this means that there is a licensing issue between the serial device server and Serial/IP. Please contact SAN technical support to obtain the correct VCOM software.

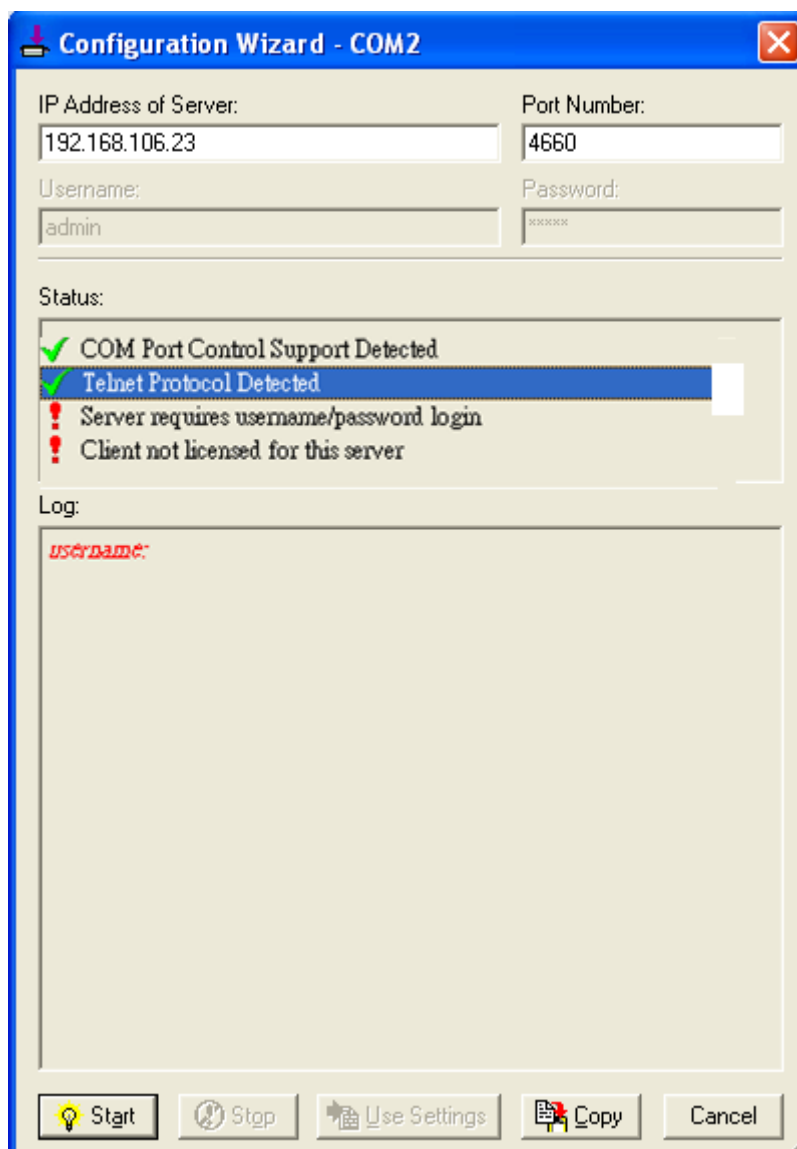

Figure 85

If the exclamation mark begins with **Server requires username/password login** Figure It means VCOM Authentication in the serial device server is enabled, but credentials in the Serial/IP are not enabled.

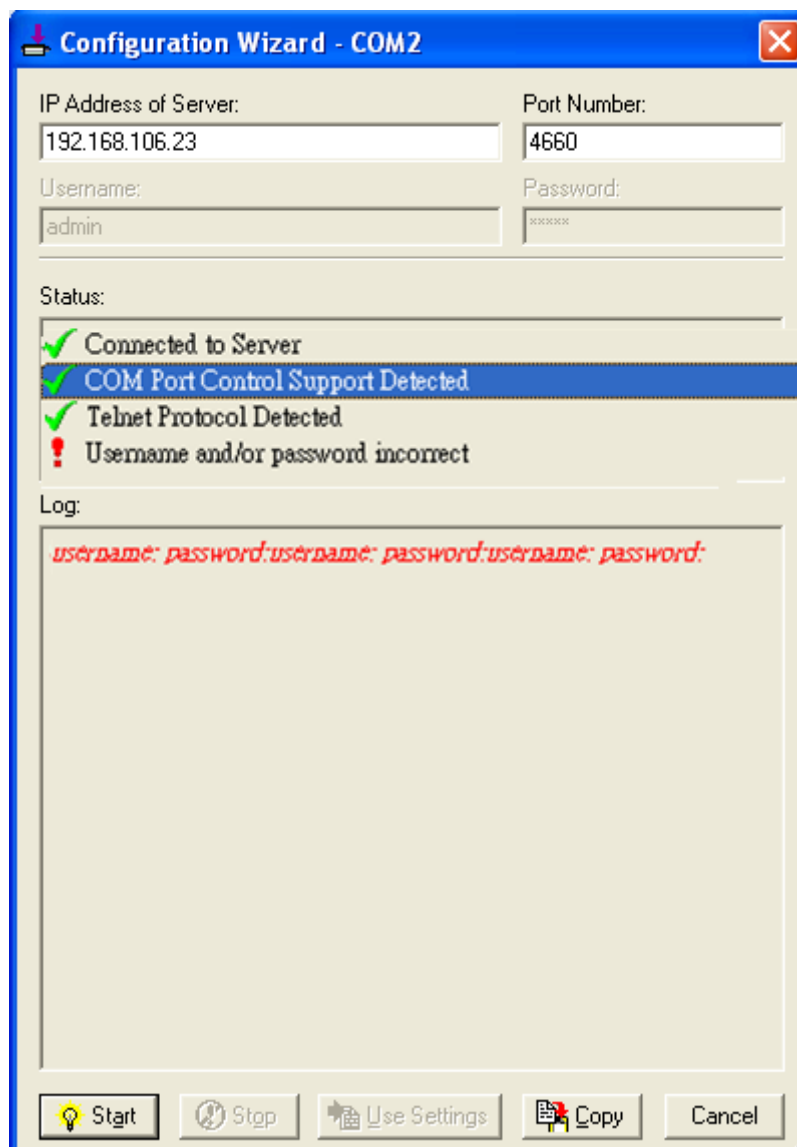

Figure 86

If the exclamation mark begins with a **“Username and/or password incorrect”**, Figure ; this means the wrong username and/or password were entered and the authentication process failed.

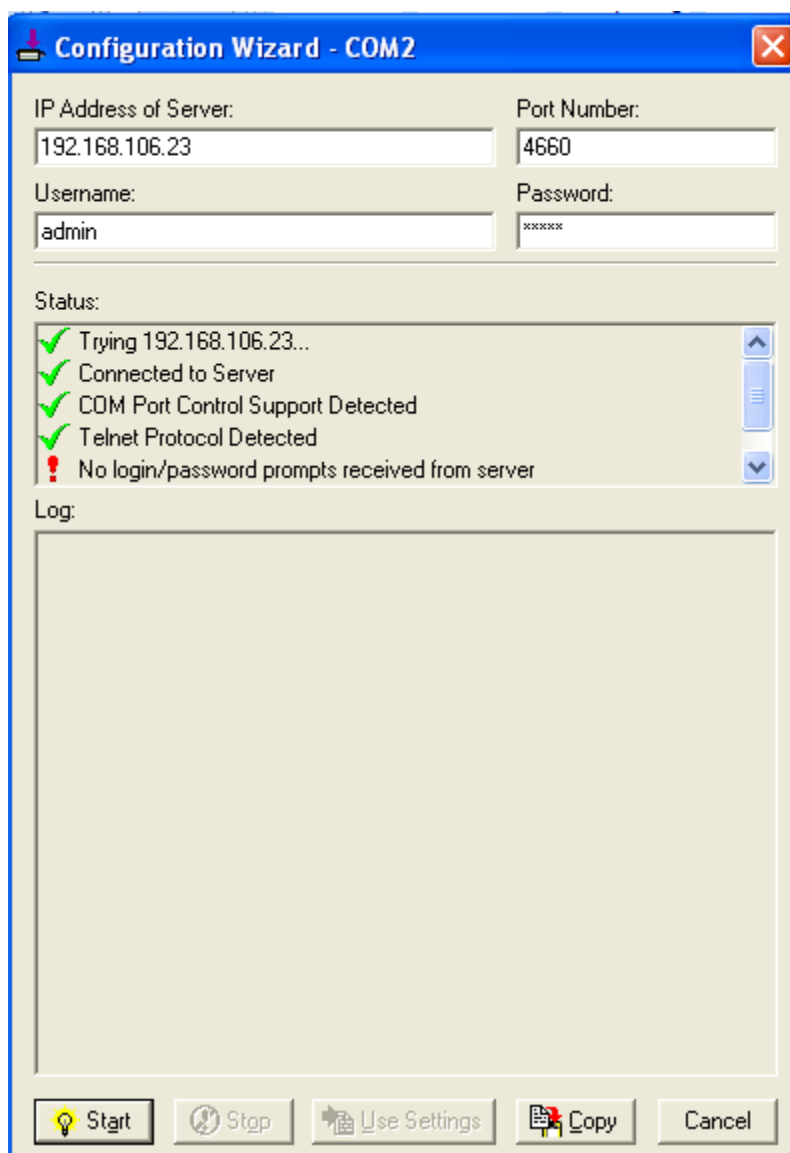

Figure 87

If the exclamation mark begins with **No login/password prompts received from server** Figure, it means credentials in the **Serial/IP** is enabled, but **VCOM Authentication** in the serial device server is not enabled.

5.3 Using Serial/IP Port Monitor

5.3.1 Opening the Port Monitor

The Serial/IP Port Monitor can be opened by:

- Start→ All Programs→ Serial/IP→ Port Monitor
- Double click the Serial/IP tray icon in the Windows notification area.
- In the Windows notification area, right click in the Serial/IP tray icon and click on **Port Monitor** to open the Port Monitor.
- Click on the **Port Monitor** button in the Serial/IP Control Panel

5.3.2 The Activity Panel

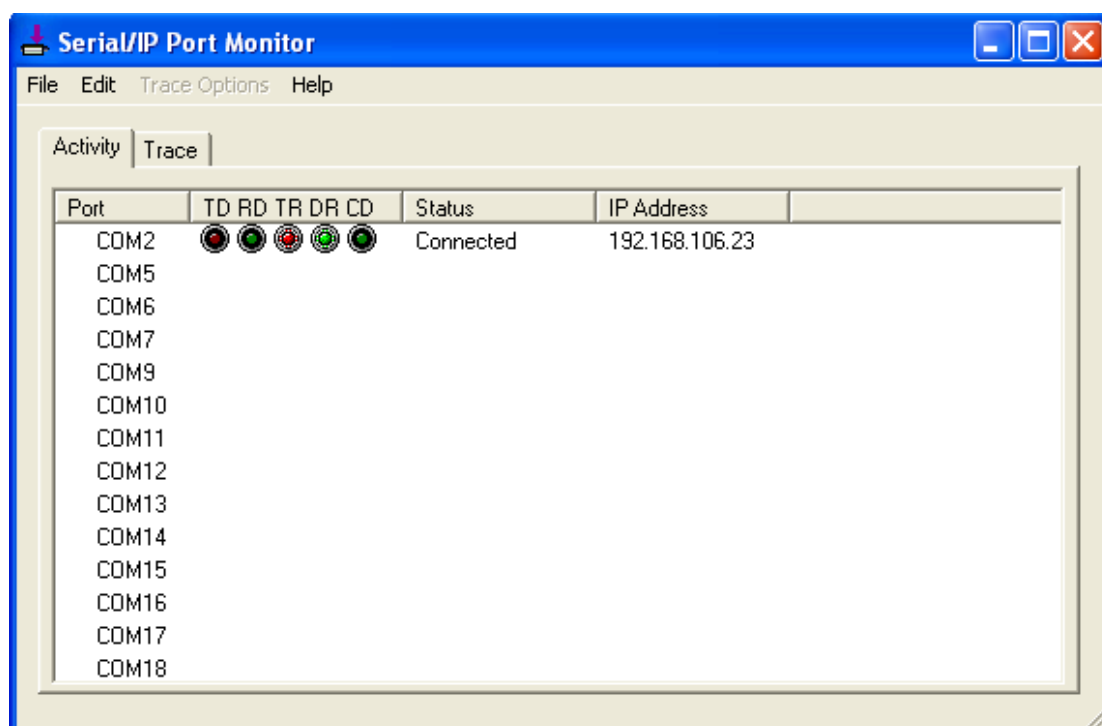

Figure 88

The Activity panel provides a real-time display of the status of all Serial/IP COM ports, Figure . If the Virtual COM Port is open and is properly configured to connect to a serial device server, the status would be **Connected**. If Serial/IP cannot find the specified serial device server, the status would be **Offline**.

5.3.3 The Trace Panel

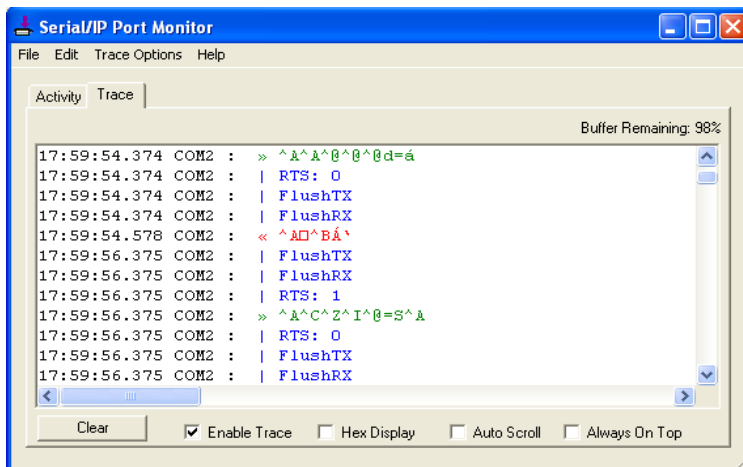

Figure 89

The Trace panel provides a detailed, time-stamped, real-time display of all Serial/IP COM ports operations, Figure . Click on **Enable Trace** to start logging Virtual COM communication. Click on File → Save As and send the log to SAN for analysis if problems arise with Virtual COM.

5.3.4 Serial/IP Advanced Settings

In the Serial/IP Control Panel, Click on the **Advanced** button to open Advanced Settings window, Figure . Click on **Use Default Settings** to load the default settings.

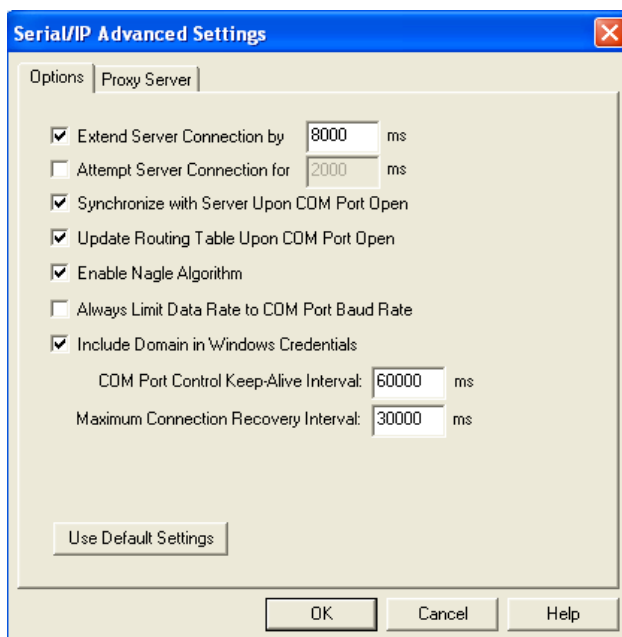

Figure 90

- **Extend Server Connection** Maintains the TCP connection for specified amount of time after

COM port is closed

- **Attempt Server Connection** Terminates pending connection attempts if they do not succeed in the specified time
- **Synchronize with Server Upon COM Port Open** Required by NT Systems (2000, XP, Vista, 7)
- **Update Routing Table Upon COM Port Open** Maintains IP route to a server in a different subnet by modifying the IP routing table
- **Enable Nagle Algorithm** Provides better network efficiency by imposing a minor latency on the data stream while it waits to fill network packets
- **Always Limit Data Rate to COM Port Baud Rate** Limits the data rate to the baud rate that is in effect for the virtual COM port
- **Attempt Server Connection** If credential is set to Windows Credentials, VCOM automatically adds the current Windows domain to the username
- **COM Port Control Keep-Alive** Controls the interval at which VCOM will issue the keep-alive message, if no there is no activity
- **Maximum Connection Recovery Interval** Controls the maximum time for “Restore Failed Connection”

Enable SETXON/SETXOFF COM Port Commands This option enables additional negotiation on SETXON and SETXOFF commands and is only available for the “V” series serial device servers. If the application requires SETXON/SETXOFF feature, please contact SAN Tech Support.

5.3.5 Using Serial/IP with a Proxy Server

The Serial/IP Redirector supports TCP network connections made through a proxy server, which may be controlling access to external networks (such as the Internet) from a private network that lacks transparent IP-based routing, such as NAT. Find Proxy Server settings from the Advanced Settings windows and switch to the **Proxy Server** tab, Figure .

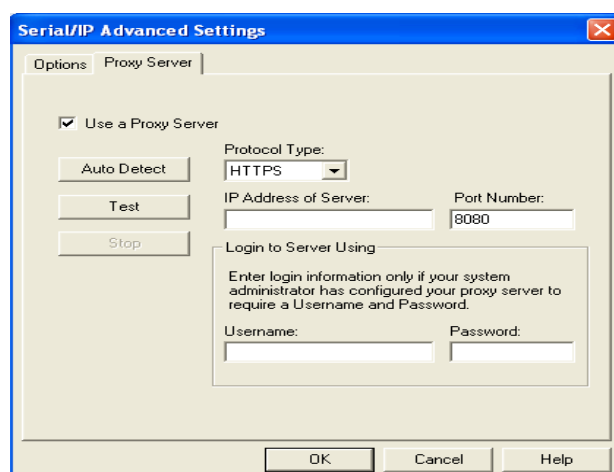

Figure 91

6 Specifications

6.1 Hardware

Network Interface	
Ethernet	2x RJ'45 IEEE802.3u 10/100 Mbps
Auto MDI/MID-X	No
Ethernet Port redundancy Switch over time	100 ms
Serial Interface	
Connector	RJ-45 RS-232/422/485 software selectable
Ports	8/16 Ports
Baud Rate	300~921600Kbps
Parity	None, Odd, Even, Space, Mark
Data Bits	5,6,7,8
Stop Bits	1,2
Flow Control	None, Xon/Xoff, RTS/CTS
Power Characteristics	
Input Voltage	100-240VAC
Input Current (100VAC)	0.09A
Power Consumption	Approx. 8.5W (max)
Power Redundancy	No
Reverse Polarity Protection	Yes
Connector	AC Inlet
Mechanicals	
Dimensions	436 mm x 43.5 mm x 200 mm
Installation	Rack Mount
Reset Button	Yes
Weight	3000 g
Environmental Limits	
Operating Temperature	0°C~60°C (32°F~140°F)
Storage Temperature	-40°C~85°C (-40°F~185°F)
Ambient Relative Humidity	5~95% RH, (non-condensing)

6.2 Software

Protocols	DHCP Client, DNS, ERPS, HTTP, ICMP, IPv4, NTP, RFC2217, SMTP, SNMP, STP, Syslog, TCP, Telnet, UDP
Configuration	Serial Manager, Web UI, Serial console, Telnet
Virtual COM	Windows / Linux redirection software
Link Modes	
TCP Server	4 connections, Virtual COM, or Reverse Telnet
TCP Client	Dual destinations or Virtual COM
UDP	Up to 8 ranges of IPs

6.3 Pin Assignments

6.3.1 Serial and RJ-45 Connectors

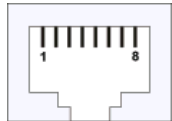
		Ethernet	RS-232	RS-422	RS-485
Pin 1	Tx+	RTS	-	-	-
Pin 2	Tx-	DTR	TX-	-	-
Pin 3	Rx+	TXD	TX+	-	-
Pin 4		SG	SG	SG	SG
Pin 5		SG	SG	SG	SG
Pin 6	Rx-	RXD	RX+	Data+	
Pin 7		DSR	RX-	Data-	
Pin 8		CTS	-	-	-

6.3.2 Serial and Female DB9 Connectors

	RS-232	RS-485	RS-422
Pin 1	-	-	-
Pin 2	RXD	Data+	RX+
Pin 3	TXD	-	TX+
Pin 4	DTR	-	TX-
Pin 5	SG	SG	SG
Pin 6	DSR	Data-	RX-
Pin 7	RTS	-	-
Pin 8	CTS	-	-
Pin 9	-	-	-

6.3.3 Serial and Male DB9 Connectors

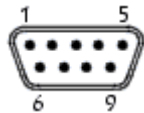
	RS-232	RS-485	RS-422
Pin 1	-	-	-
Pin 2	RXD	Data+	RX+
Pin 3	TXD	-	TX+
Pin 4	DTR	-	TX-
Pin 5	SG	SG	SG
Pin 6	DSR	Data-	RX-
Pin 7	RTS	-	-
Pin 8	CTS	-	-
Pin 9	-	-	-

6.3.4 RJ-45 to Female DB9 Connection

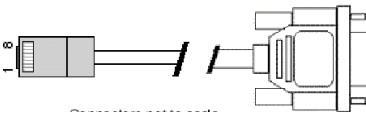
RJ45		Cross Over Female DB9		
				
RTS	Pin 1	↔	Pin 8	CTS
DTR	Pin 2	↔	Pin 6	DSR
TXD	Pin 3	↔	Pin 2	RXD
SG	Pin 4	↔	Pin 5	GND
SG	Pin 5			
RXD	Pin 6	↔	Pin 3	TXD
DSR	Pin 7	↔	Pin 4	DTR
CTS	Pin 8	↔	Pin 7	RTS

6.3.5 RJ-45 to Male DB9 Connection

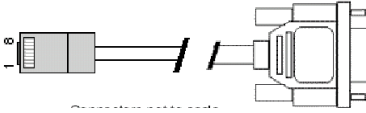
RJ45		Straight Through Male DB9		
				
RTS	Pin 1	↔	Pin7	RTS
DTR	Pin 2	↔	Pin4	DTR
TXD	Pin 3	↔	Pin3	TXD
SG	Pin 4	↔	Pin 5	SG
SG	Pin 5			
RXD	Pin 6	↔	Pin2	RXD
DSR	Pin 7	↔	Pin6	DSR
CTS	Pin 8	↔	Pin 8	CTS

Connection Details

For RS485 4 Wire /RS422

Signal of SC10E16A	Will Connect to
TX+	RX+ of your device
TX-	RX- of your device
RX+	TX+ of your device
RX-	TX- of your device

For RS485 2 Wire

Signal of SC10E16A	Will Connect to
DATA +	TX+ /D+ of your device
DATA -	TX- /D- of your device

For RS232

Connect a Cross cable from SC10E16A RS232 Port (RJ45) connector to PC COM Port connector.

PC Side 9 Pin Male	Signal	SC10E16A Side RJ45 Connector
1	DCD	-
2	RXD	3
3	TXD	6
4	DTR	7
5	GND	4,5
6	DSR	2
7	RTS	8
8	CTS	1
9	RI	-

6.4 LED Indicators

Name	Color	Status	Message
Power	Green	On	Power is connected
		Off	Power is not connected
Ready	Green	On	Booting up
		Blinking	In Activity
COM (Tx / Rx)	Green	Blinking	SerialPort Transmission
		Off	No Data Transmission
LAN	Orange	On	Ethernet is connected at 100Mbps
	Green	Off	Ethernet is Disconnected
		Blinking	Data is transmitting on Ethernet

6.5 Buzzer

Message	Description
====^=====	Startup OK and AP firmware is enabled

“^”Beep“=”Beep off

7 Upgrade System Firmware

7.1 Upgrade Procedure

- Obtain new firmware from [SAN](#)
- Make sure the PC and the SC10E08A/ SC10E16A1 Series are on the same network; use the ping command or Serial Manager© utility for it.
- Edit “dll.bat” to fit the system requirements, be sure to save your settings before.
- Run linux_dl, for example: linux_dl_v2_zImage.bin 10.0.50.100
- SC10E08A/ SC10E16A1 Series will automatically restart each time after the firmware is successfully downloaded. The upgrade process should take around one minute.

Note:Note: “linux_dl_v2” is the executable upgrade and zImage.bin is the firmware file name; xxx.xxx.xxx.xxx is the SC10E08A/ SC10E16A1 Series’ IP address.

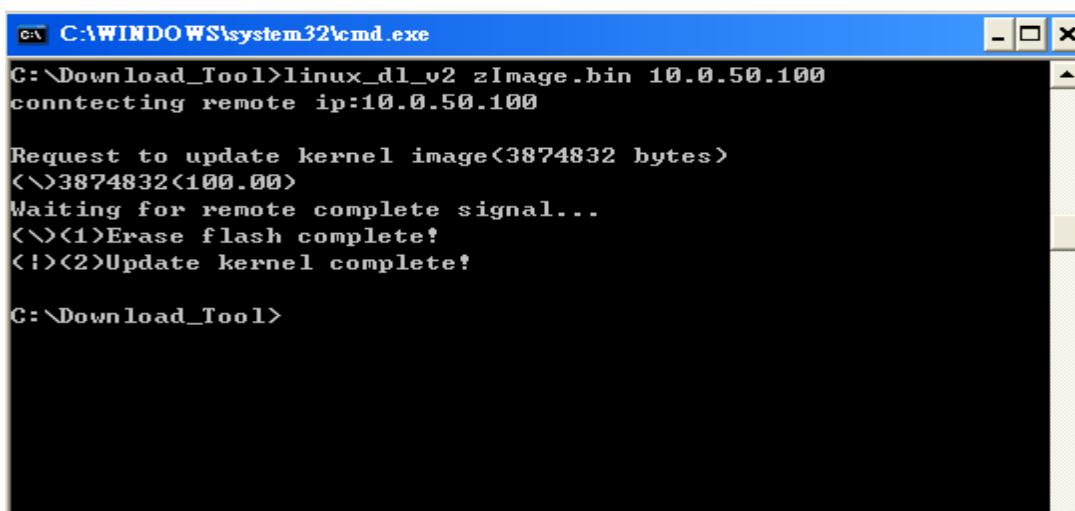

```
C:\WINDOWS\system32\cmd.exe
C:\Download_Tool>linux_dl_v2 zImage.bin 10.0.50.100
connecting remote ip:10.0.50.100

Request to update kernel image(3874832 bytes)
<\>3874832<100.00>
Waiting for remote complete signal...
<\><1>Erase flash complete!
<!><2>Update kernel complete!

C:\Download_Tool>
```

7.2 Error Messages

Firmware upgrade may not be successful if errors occurred during the process.

Error Cause	Message
Illegal Hex file format	Hex File Text Error Hex File Check-Sum Error Hex File Format Error Hex File End of Record Error
Handshaking problem	SC10E08A/ SC10E16A1 Series ACK Start Address Error SC10E08A/ SC10E16A1 Series ACK length Error SC10E08A/ SC10E16A1 Series ACK Response Command Error
Configuration file	Remote IP not found Open configuration file failure

Rack With Clamp

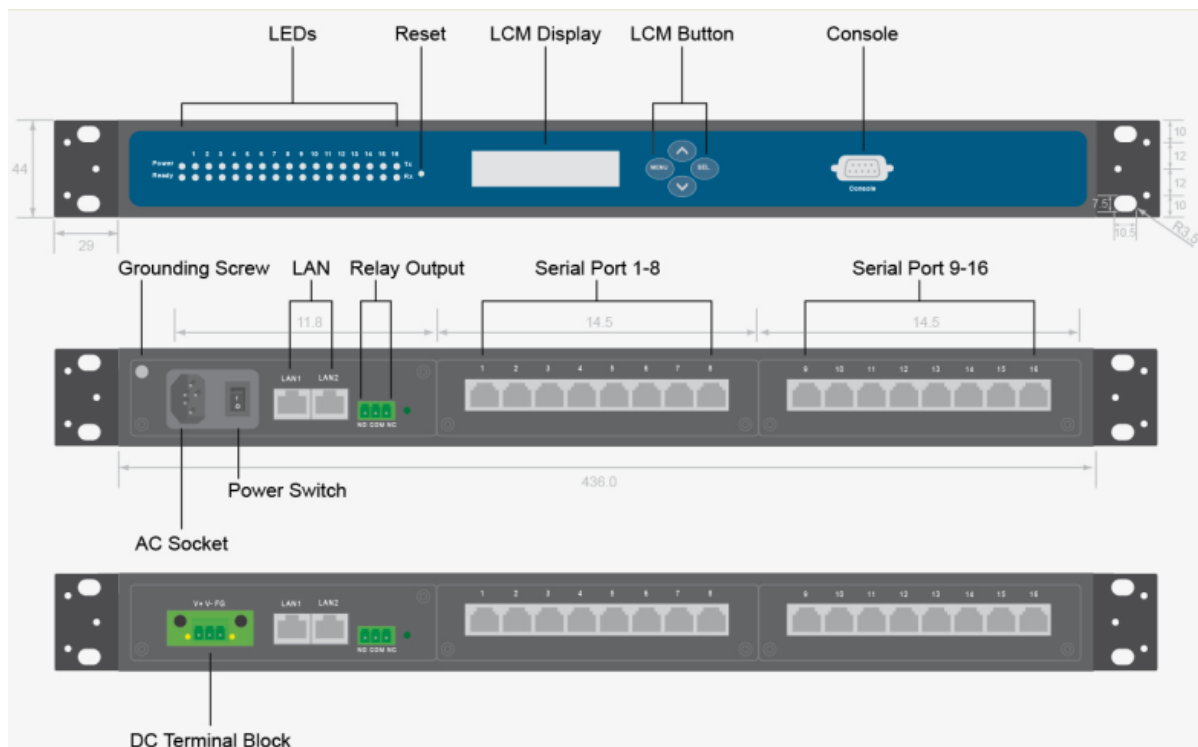

San Telequip Private Limited.,
504/505 Deron Heights, Baner Road, Baner
Pune 411045, Mah, India
Phone: +91-20-27293455,9764027070,8390069393
email:info@santelequip.com



Connecting. Converting. Leading!